

# Antenna 101128

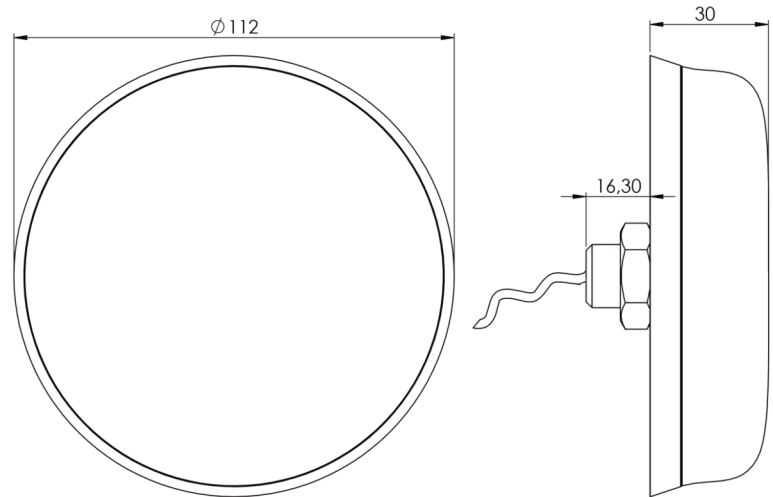

## LTE-MIMO antenna



### Technical data:

Frequency Range:	GSM 850/900/1800/1900 MHz + UMTS inkl. LTE Band: 1, 2, 3, 4, 5, 8, 25, 26 + Band 7, 13, 20 (4G)
VSWR*:	< 2.0 typ.
Peak Gain*:	-9 dBi typ. (700 MHz) 0 dBi typ. (800 MHz) +3 dBi typ. (900 MHz) +3 dBi typ. (1800 MHz) +1 dBi typ. (2100 MHz) +2 dBi typ. (2600 MHz)
Power:	max. 10 W

\* measured with 0.60m cable on 30x30cm ground plane

### Dimensions and connectors:

Dimensions (∅/h):	approx. 112 mm x 30 mm
Mounting:	roof mounting (bracket for wall mounting on request)
Temperature range:	-40°C to +85°C (operating temperature)
Connection (standard):	2x3m cable RG174 lowloss with connectors SMA (male) (other cable-lengths or connectors on request)

>> **Waterproof TÜV passed IP69K mounted** <<

# Antenna 101128

## LTE-MIMO antenna



### Radiation Pattern

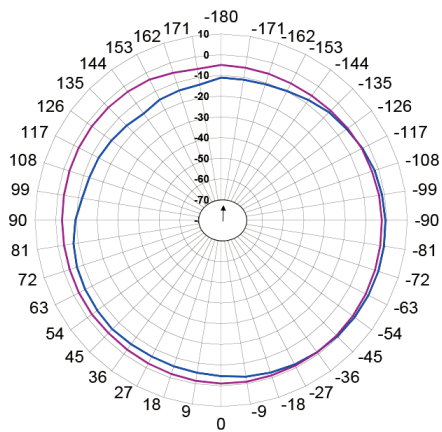

**GSM 2**  
Azimuth

Frequenz :  
— 824  
— 858

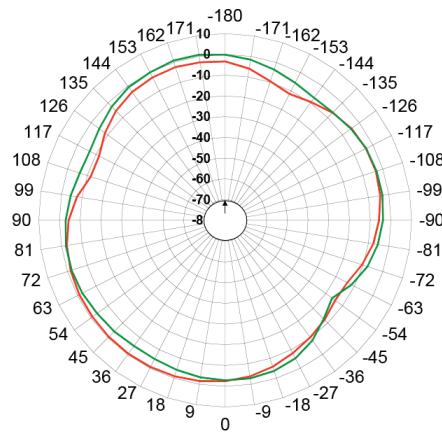

**LTE 2**  
Azimuth

Frequenz :  
— 1900  
— 2100

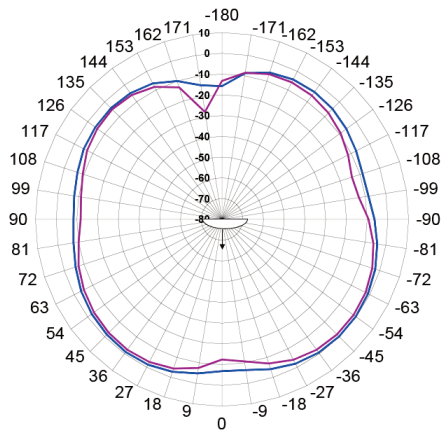

**GSM 2**  
Elevation 90

Frequenz :  
— 824  
— 926

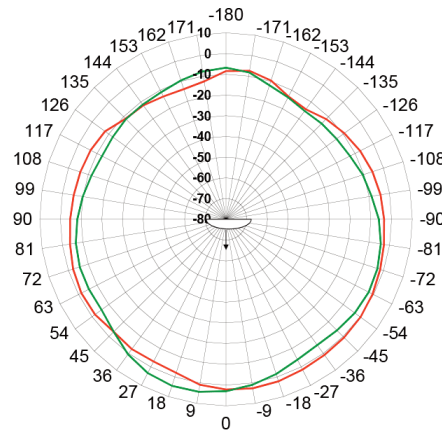

**LTE 2**  
Elevation 90

Frequenz :  
— 1900  
— 2100

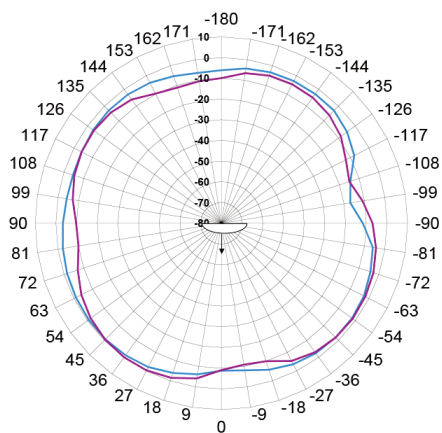

**GSM 2**  
Elevation 0

Frequenz :  
— 824  
— 926

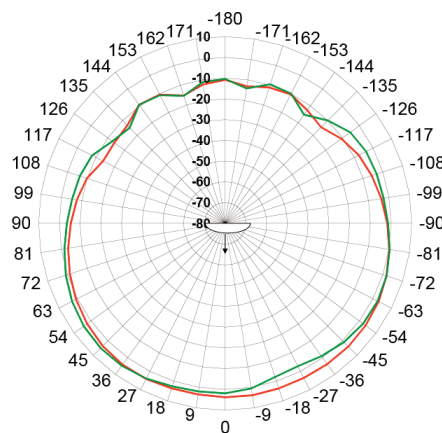

**LTE 2**  
Elevation 0

Frequenz :  
— 1900  
— 2100

# Antenna 101128



## LTE-MIMO antenna



### VSWR:

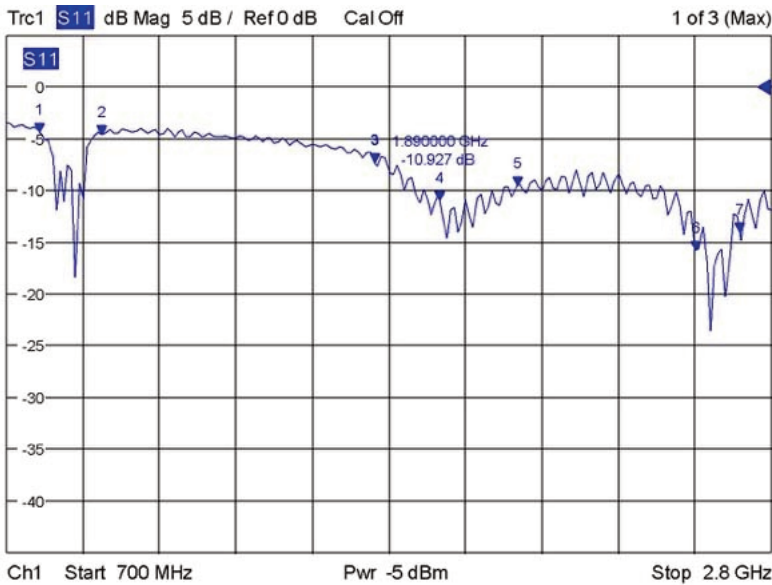

Date: 1.DEC.2016 16:48:44

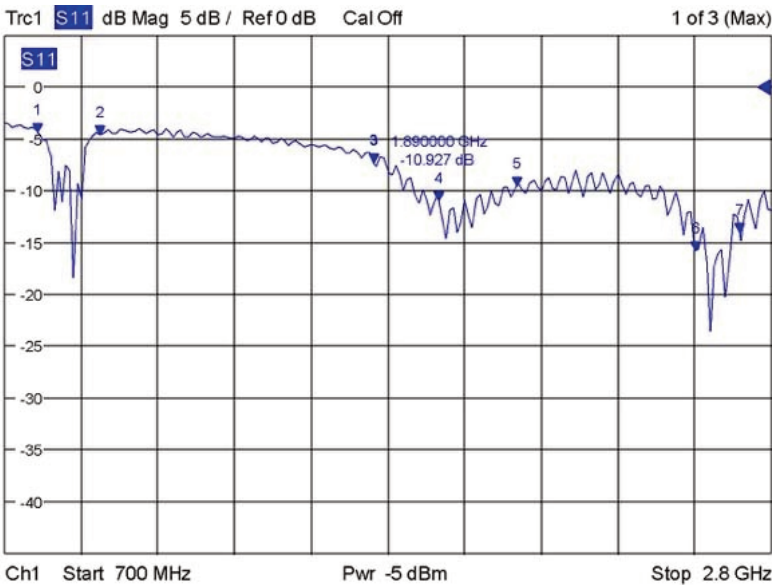

Date: 1.DEC.2016 16:48:44