

Wall Mount Directional Gain Antenna

WM8E-BADEP3G-26-NJ



- High gain
- Mast mount or wall mount
- SAR tested to EN50385:2002
- Integrate wireless services into one antenna

A versatile high gain directional antenna ideal for indoor and outdoor deployment, Panorama's WM8E range allows businesses and individual users to boost or distribute 2G/3G and 4G signal from their router or repeater.

The WM8E-BADEP3G-26-NJ supports 2G, 3G, 3G+ and 4G technologies including LTE, AMPS, PCS, GSM, UMTS & AWS with lower gain coverage of WIFI 2.4GHz and LTE 2.6GHz.

The WM8E range is housed in impact resistant, UV light stabilised plastic. The features a heavy duty N female connector suitable for kitting with a range of cable extensions.

Technical Drawing

WM8E-BADEP3G-26-NJ Shown

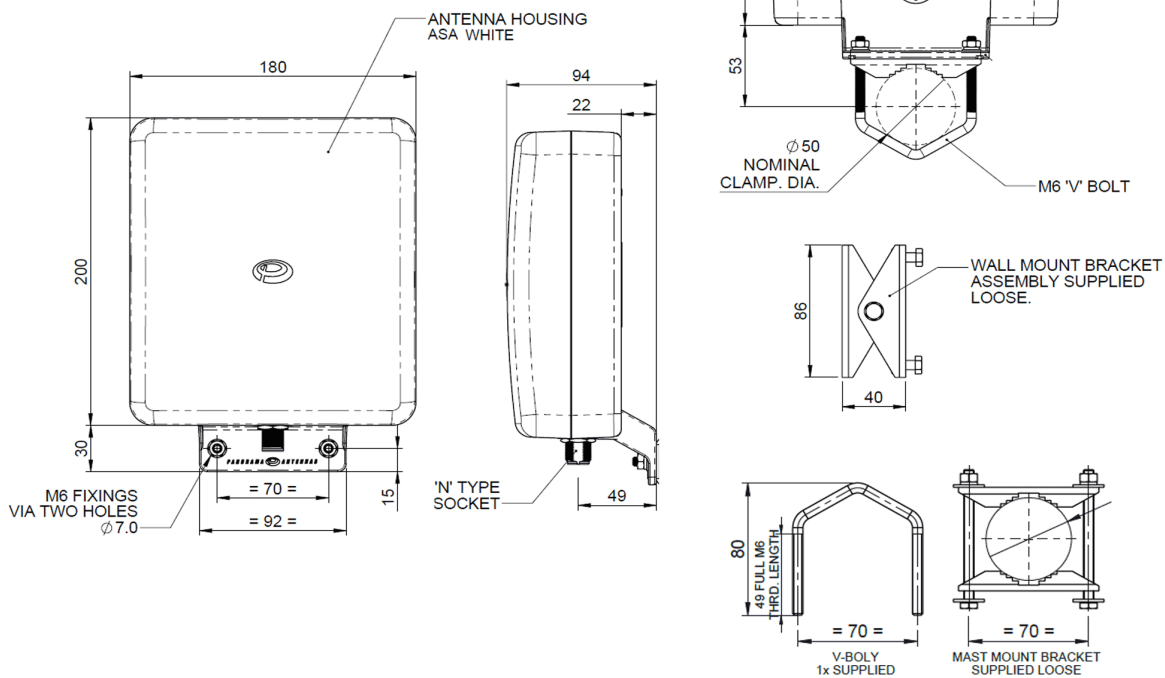

Wall Mount Directional Gain Antenna

WM8E-BADEP3G-26-NJ

Product Data

Part No.		WM8E-BADEP3G-26-NJ
Electrical Data		
Frequency Range (MHz)	698-960, 1710-2700	
Operational Band	LTE700, AMPS 850, CDMA 800, GSM1800, PCS1900, 3G UMTS, AWS, WIFI (2.4GHz), LTE 2.6	
Peak Gain: Isotropic	LTE 700MHz, AMPS800 & GSM900	6.5dBi
	GSM1800, PCS1900, 3G UMTS / AWS 2100	9dBi
	WIFI 2400, LTE 2600	6dBi
VSWR	<2.5:1	
Polarisation	Vertical	
Pattern	Directional	
SAR and 'Touch Safe' Test Data	According to 50385:2002 (Bands: 850, 900, 1800, 2100, 2600MHz)	
Impedance	50Ω	
Max Input Power (W)	50	
Mechanical Data		
Dimensions (mm)	Height	230mm (9.05")
	Width	180mm (7.08")
	Length	94mm (3.7")
Operating Temp (°C)	-30° / +70°C (-22° / 158°F)	
Material	ASA	
Colour	White	
Ingress Protection	IP66K	
Connector Data		
Type	N Socket	
Mounting Data		
Fixing	Pole Mount / Wall Mount	
Pole Diameter	20-50 mm (0.8 - 1.96")	

Wall Mount Directional Gain Antenna

WM8E-BADEP3G-26-NJ

Product Data

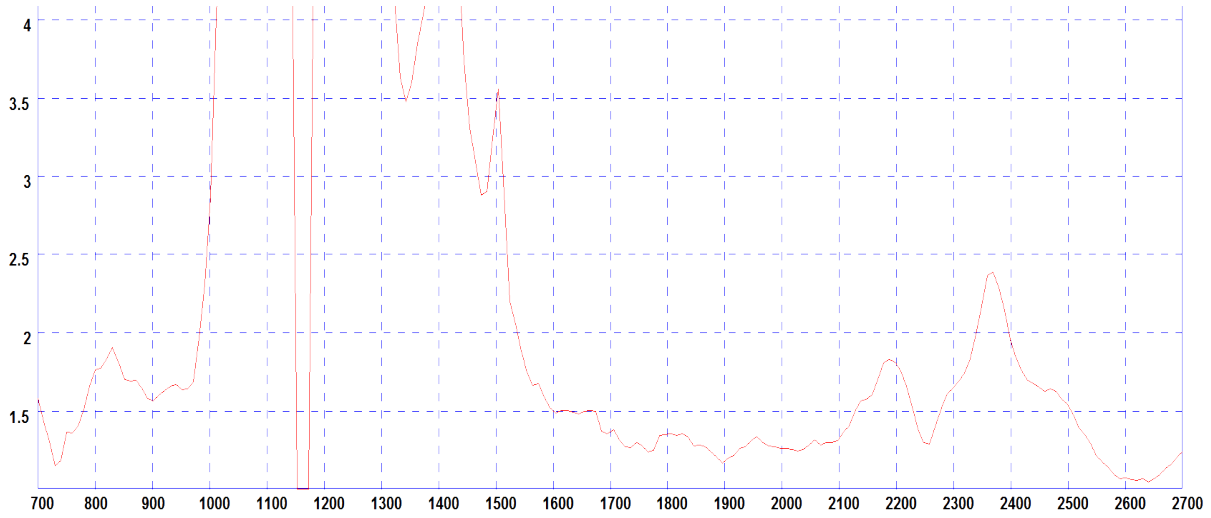

*Measurements taken looking directly into N connector on antenna housing.

Radiation Plots

Typical H Plane 700MHz

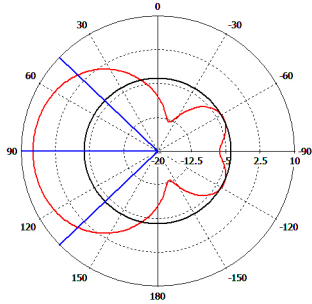

Typical H Plane 850MHz

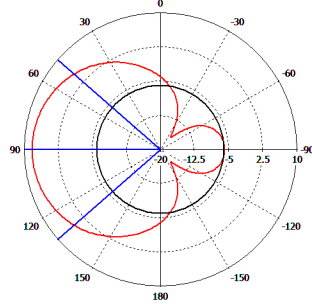

Typical H Plane 1700MHz

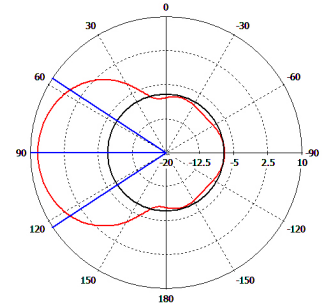

Typical H Plane 1800MHz

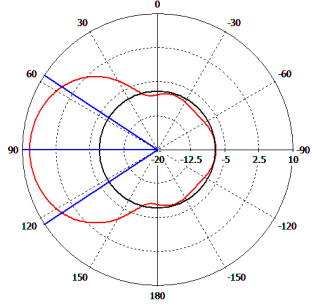

Typical H Plane 1900MHz

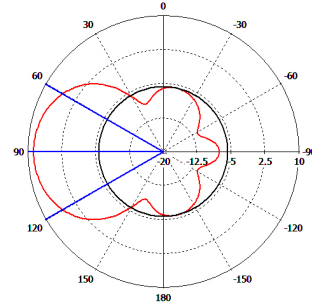

Typical H Plane 2100MHz

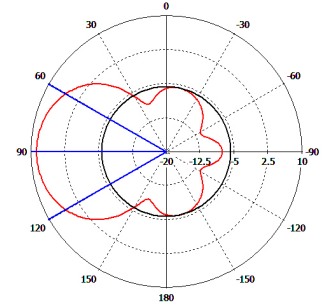

Typical H Plane 2400MHz

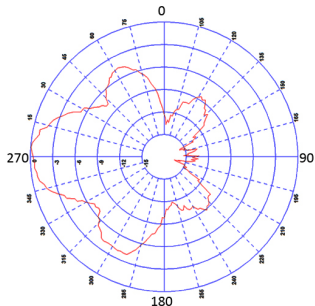

Typical H Plane 2600MHz

