

AGH CONNECTOR

Disconnectable Crimp style connectors

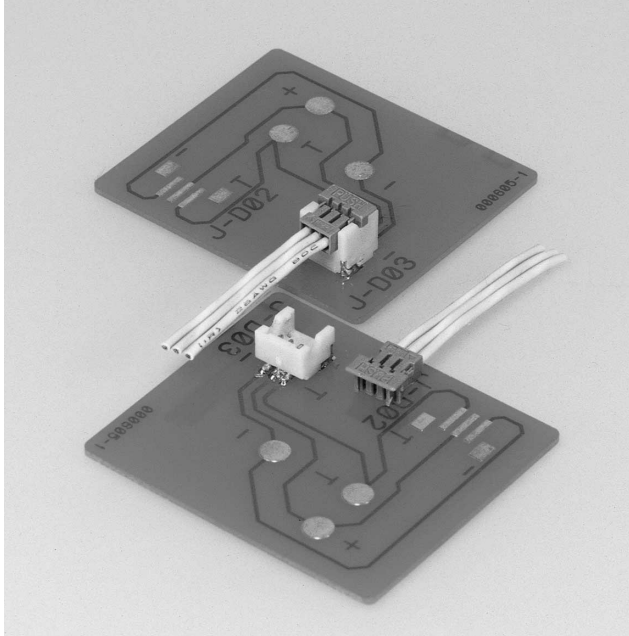

1.25mm pitch crimp type connector. This connector system has excellent operational advantages due to its top entry style. In addition, with the wires on the side, it is low profile, similar to a side entry style.

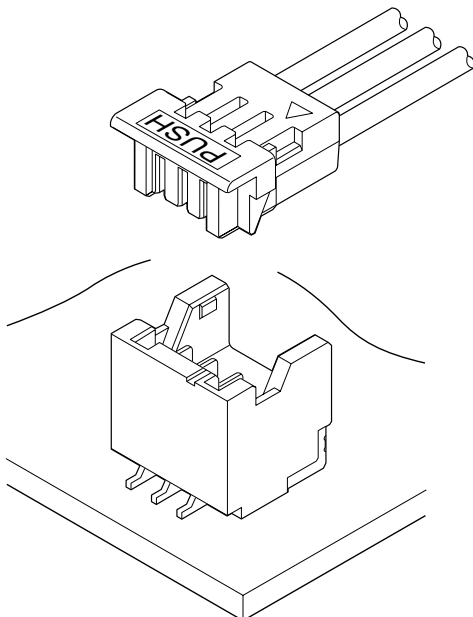

Features

• Miniaturization

Developed for mobile phone battery connection. The mounting height of 6.1mm, but can be reduced to 4.4mm depending on the design at low profile header side.

• Distortion resistant construction

Because of the unique rib structure of the housing, the connector is resistant to distortion when extracting.

• Applicable to surface mounting technology

The header has a sufficient area for suction for the use of automatic surface mounting system.

Specifications

- Current rating: 1.0A AC, DC (AWG #26)
 - Voltage rating: 50V AC, DC
 - Temperature range: -25°C to +85°C
(including temperature rise in applying electrical current)
 - Contact resistance: Initial value/20m Ω max.
After environmental testing/30m Ω max.
 - Insulation resistance: 500M Ω min.
 - Withstanding voltage: 500V AC/minute
 - Applicable wire: AWG #30 to #26
Insulation O.D./0.8 to 1.0mm
- * RoHS compliant products are published.
* Refer to "General Instruction and Notice when using Terminals and Connectors" at the end of this catalog.
* Contact JST for details.

Standards

 Recognized E60389

 J50014042

Contact

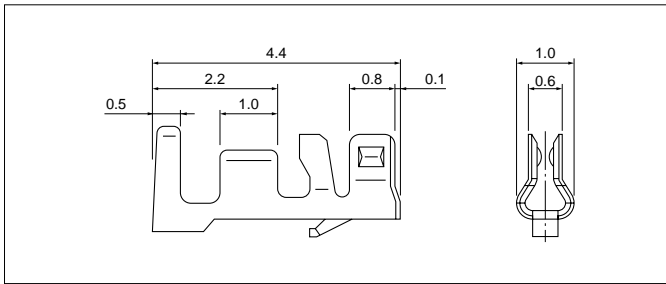

Model No.	Applicable wire		Insulation O.D. (mm)	Q'ty / reel
	mm ²	AWG #		
SAGH-002GU-P0.3	0.05 to 0.13	30 to 26	0.8 to 1.0	20,000

Material and Finish

Phosphor bronze, nickel-undercoated, gold-plated

RoHS compliance

Housing

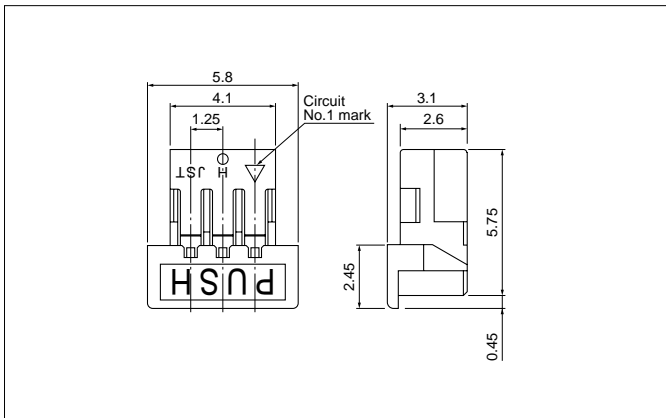

Circuits	Model No.	Q'ty / bag
3	AGHR-03V-1-H	5,000

Material

PBT, UL94V-0, gray

RoHS compliance

<For reference> As the color identification, the following alphabet shall be put in the underlined part. For availability, delivery and minimum order quantity, contact JST.

ex. **AGHR-03V-1-00**

H...gray

(blank)...natural

Shrouded header

<5.6mm type>

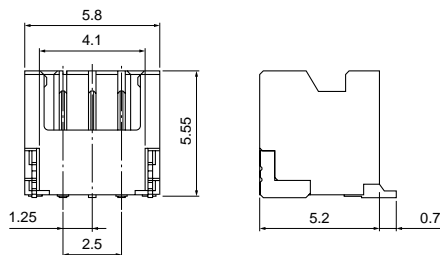

<3.9mm type>

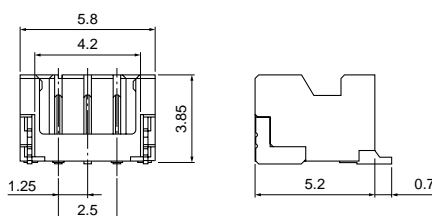

●5.6mm type

Circuits	Model No.	Q'ty / reel
3	BM03B5.6-AGHS-GG-TF	1,000

Material and Finish

Contact: Phosphor bronze, nickel-undercoated,
Mating part: gold-plated
Solder tail: tin-plated (reflow treatment)
Housing: PA 9T, UL94V-0, natural
Solder tab: Brass, copper-undercoated, tin-plated (reflow treatment)

RoHS compliance This product displays (LF)(SN) on a label.

●3.9mm type

Circuits	Model No.	Q'ty / reel
3	BM03B3.9-AGHS-GH-TF	1,250

Material and Finish

Contact: Phosphor bronze, nickel-undercoated,
Mating part: gold-plated 0.4μm
Solder tail: gold-plated flash
Housing: PA9T, UL94V-0, natural
Solder tab: Brass, copper-undercoated, tin-plated (reflow treatment)

RoHS compliance This product displays (LF)(SN) on a label.

AGH CONNECTOR

PC board layout (viewed from component side) and Assembly layout

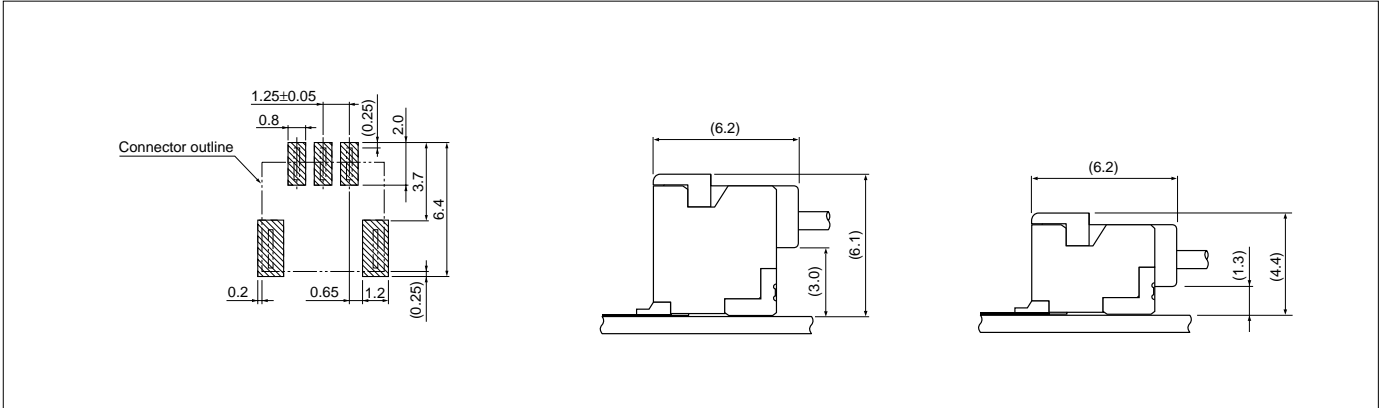

Note:

1. Tolerances are non-cumulative: $\pm 0.05\text{mm}$ for all centers.
2. The dimensions above should serve as a guideline. Contact JST for details.

Crimping machine, Applicator

Contact	Crimping machine	Crimp applicator	Dies	Crimp applicator with dies
SAGH-002GU-P0.3	AP-K2N	MKS-L-10-3	MK/SAGH-002-03	APLMK SAGH002-03
		*MKS-SC	SC/SAGH-002-03	APLSC SAGH002-03

Note: *Strip-crimp applicator