

FKZ CONNECTOR

Connectors for FPC

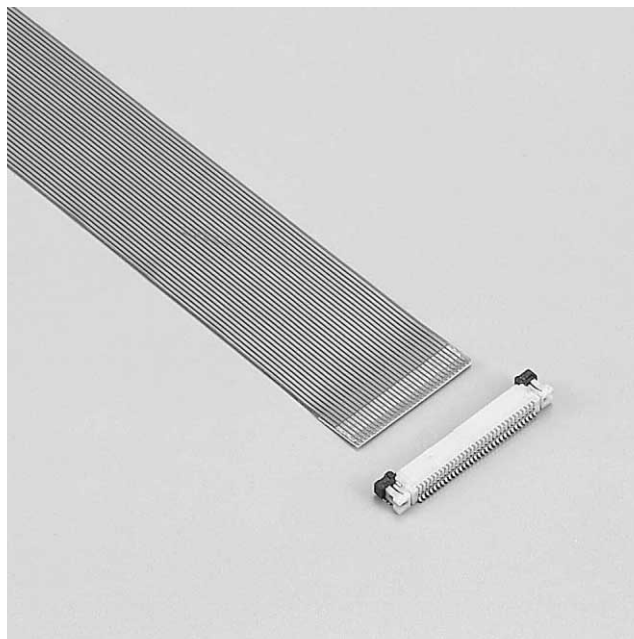

Available both in normal type and reverse type.

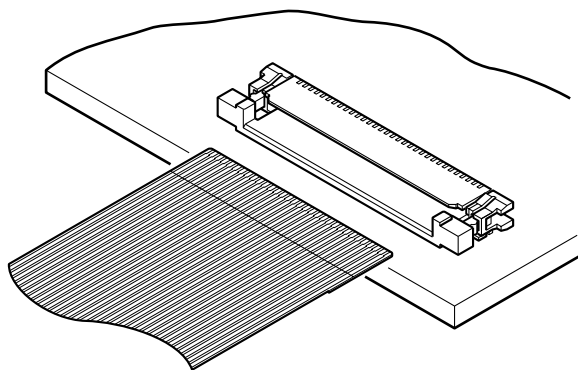

Features

• Space saving

The depth is 3.5mm for the connectors of 25 circuits or less, and 4.0mm for 26 circuits or more.

• Low profile

Only 1.8mm height after mounted on the PC board.

• Zero insertion force mechanism

A ZIF mechanism increases wear resistance and extends the connector's mating life.

Specifications

- Current rating: 0.5A AC, DC
- Voltage rating: 50V AC, DC
- Temperature range: -25°C to +85°C
(including temperature rise in applying electrical current)
- Contact resistance: Initial value/20m Ω max.
After environmental testing/40m Ω max.
- Insulation resistance: 100M Ω min.
- Withstanding voltage: 200V AC/minute
- Applicable FPC: Conductor pitch/0.5mm
Conductor width/0.35mm
Mating part thickness/0.30±0.05mm

<Note>FPC to be actually used should be checked for applicability.

- * RoHS compliant products are published.
- * Refer to "General Instruction and Notice when using Terminals and Connectors" at the end of this catalog.
- * Contact JST for details.

Standards

Recognized E60389

Certified LR20812

FKZ CONNECTOR

Connector

Normal type (5 to 25 circuits)

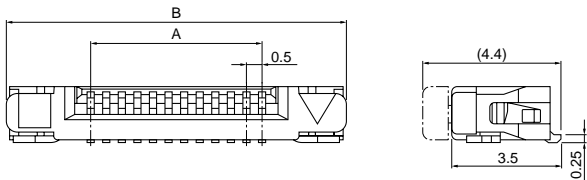

(26 to 32 circuits)

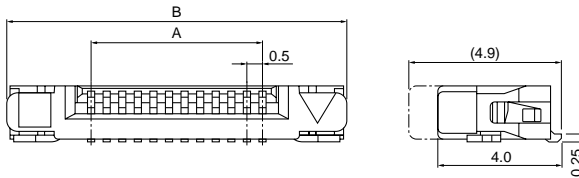

Circuits	Model No.	Dimensions (mm)		Q'ty / reel
		A	B	
5	05FKZ-SM1-1-TB	2.0	7.5	3,000
6	06FKZ-SM1-1-TB	2.5	8.0	3,000
8	08FKZ-SM1-1-TB	3.5	9.0	3,000
12	12FKZ-SM1-1-TB	5.5	11.0	3,000
14	14FKZ-SM1-1-TB	6.5	12.0	3,000
16	16FKZ-SM1-1-TB	7.5	13.0	3,000
18	18FKZ-SM1-1-TB	8.5	14.0	3,000
19	19FKZ-SM1-1-TB	9.0	14.5	3,000
20	20FKZ-SM1-1-TB	9.5	15.0	3,000
22	22FKZ-SM1-1-TB	10.5	16.0	3,000
23	23FKZ-SM1-1-TB	11.0	16.5	3,000
24	24FKZ-SM1-1-TB	11.5	17.0	3,000
26	26FKZ-SM1-2-TB	12.5	18.0	3,000
27	27FKZ-SM1-2-TB	13.0	18.5	3,000
30	30FKZ-SM1-2-TB	14.5	20.0	3,000
32	32FKZ-SM1-2-TB	15.5	21.0	3,000

Material and Finish

Contact: Phosphor bronze, copper-undercoated, tin-plated (reflow treatment)

Contact: PPS, UL94V-0

Solder tab: Brass, copper-undercoated, tin-plated (reflow treatment)

Slider: PPS, UL94V-0

RoHS compliance This product displays (LF)(SN) on a label.

Reverse type (5 to 25 circuits)

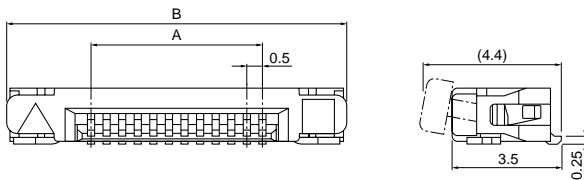

(26 to 32 circuits)

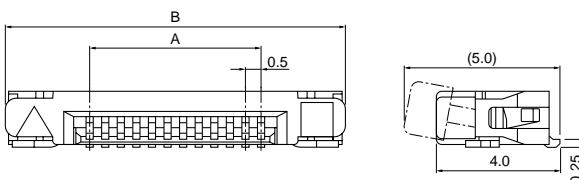

Circuits	Model No.	Dimensions (mm)		Q'ty / reel
		A	B	
5	05FKZ-RSM1-1-TB	2.0	7.5	3,000
6	06FKZ-RSM1-1-TB	2.5	8.0	3,000
8	08FKZ-RSM1-1-TB	3.5	9.0	3,000
12	12FKZ-RSM1-1-TB	5.5	11.0	3,000
13	13FKZ-RSM1-1-TB	6.0	11.5	3,000
14	14FKZ-RSM1-1-TB	6.5	12.0	3,000
16	16FKZ-RSM1-1-TB	7.5	13.0	3,000
18	18FKZ-RSM1-1-TB	8.5	14.0	3,000
19	19FKZ-RSM1-1-TB	9.0	14.5	3,000
20	20FKZ-RSM1-1-TB	9.5	15.0	3,000
22	22FKZ-RSM1-1-TB	10.5	16.0	3,000
24	24FKZ-RSM1-1-TB	11.5	17.0	3,000
26	26FKZ-RSM1-2-TB	12.5	18.0	3,000
27	27FKZ-RSM1-2-TB	13.0	18.5	3,000
28	28FKZ-RSM1-2-TB	13.5	19.0	3,000
30	30FKZ-RSM1-2-TB	14.5	20.0	3,000
32	32FKZ-RSM1-2-TB	15.5	21.0	3,000

Material and Finish

Contact: Phosphor bronze, copper-undercoated, tin-plated (reflow treatment)

Housing: PPS, UL94V-0

Solder tab: Brass, copper-undercoated, tin-plated (reflow treatment)

Slider: PPS, UL94V-0

RoHS compliance This product displays (LF)(SN) on a label.

Lead section dimensions of FPC

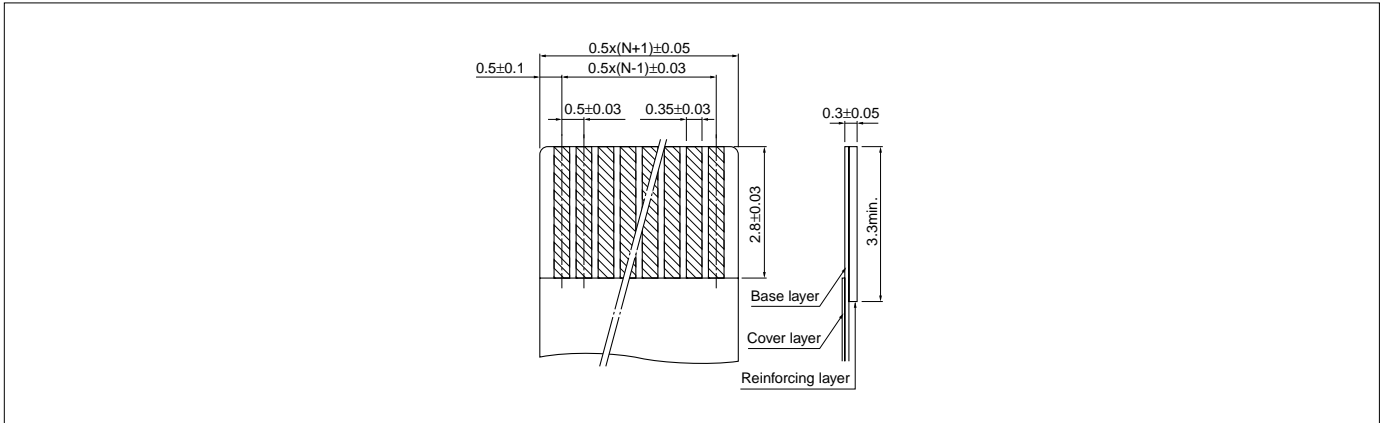

Note: N --- Number of circuits

PC board layout (viewed from component side) and Assembly layout

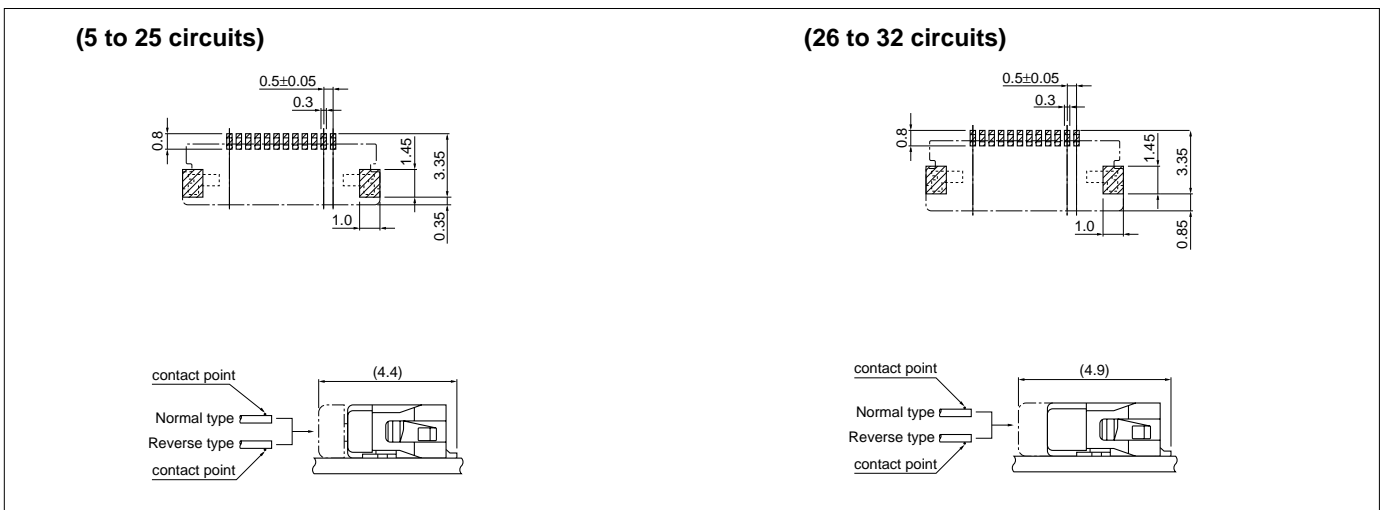

Note:

1. Tolerances are non-cumulative: ± 0.05 mm for all centers.
2. The dimensions above should serve as a guideline.
Contact JST for details.