

NEW PRODUCT

For W to B connection

SFV CONNECTOR

2.0mm Pitch

This SFV connector is a wire to board connector for connecting power supply and PCB and withstands high voltage. It is used for power supply of LED backlight in Liquid Crystal Display Television set.

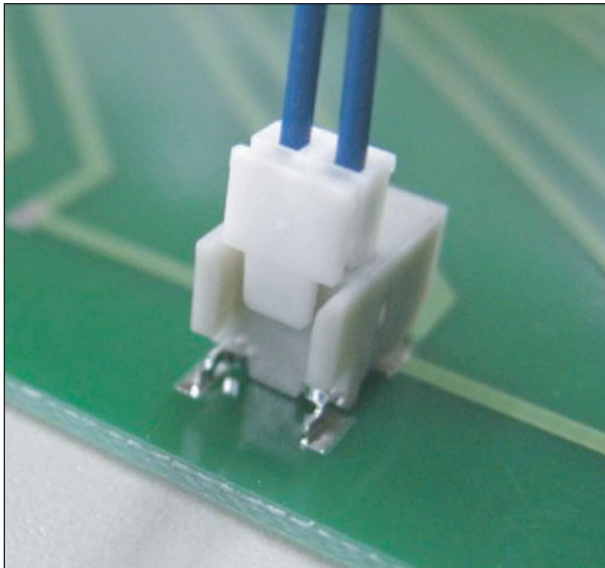

■ Features

- *Withstand high voltage*
- *Secure lock*
- *Halogen free*

■ Specifications

- Current rating : 1.0 A AC,DC (AWG #28)
- Voltage rating : 300V AC,DC
- Temperature range : -25°C to +85°C
(including temperature rise in applying electrical current)
- Contact resistance : Initial value/10mΩ max.
After environmental testing /20mΩ max.
- Insulation resistance : 1,000MΩ min.
- Withstanding voltage : AC1,700V/1minute
- Applicable wire : Wire range /AWG#30 to AWG#28
- No. of Circuits : 2-circuit
- Part number : SGVH-002T-P0.2
: BM02B-SFVH (HF)
: SFVR-02V-S (HF)

JST

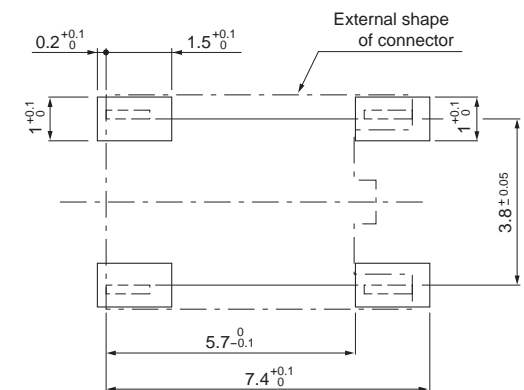
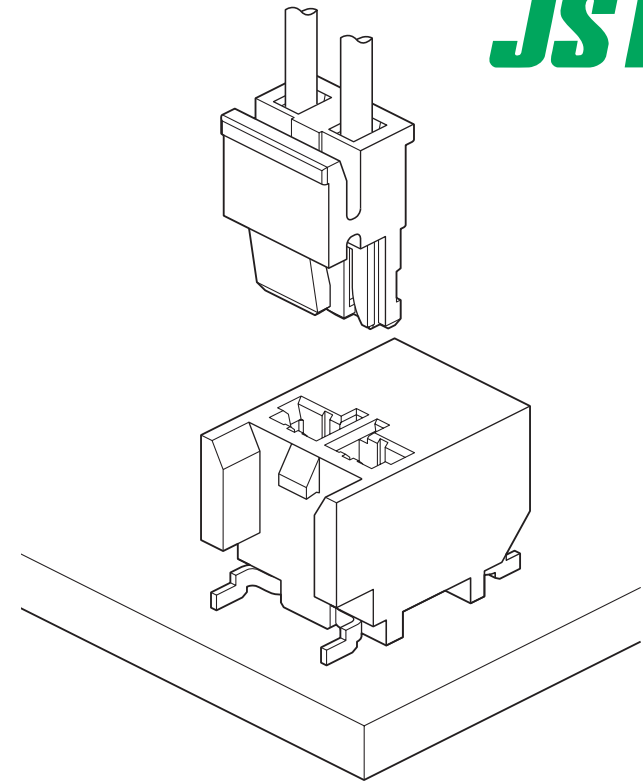

P.C.B Layout

J.S.T. MFG. CO., LTD.

<http://www.jst-mfg.com>