

Antenna 193841



5G MIMO×4 Antenna



Specifications:

5G MIMO:

Frequency Range:	698-960/1710-2690/2900-3800 MHz
V.S.W.R:	< 3.0
Polarisation:	Linear
Impedance:	50 Ω
Gain:	4 dBi typ.

Mechanical:

Cable:	4x 3 m RG174
Connector:	4x SMA (male)
Mounting Methode:	Screw
Operating temperature range:	-40°C to +85°C
Ingress Protection:	IP67 (excl. cable outlet)

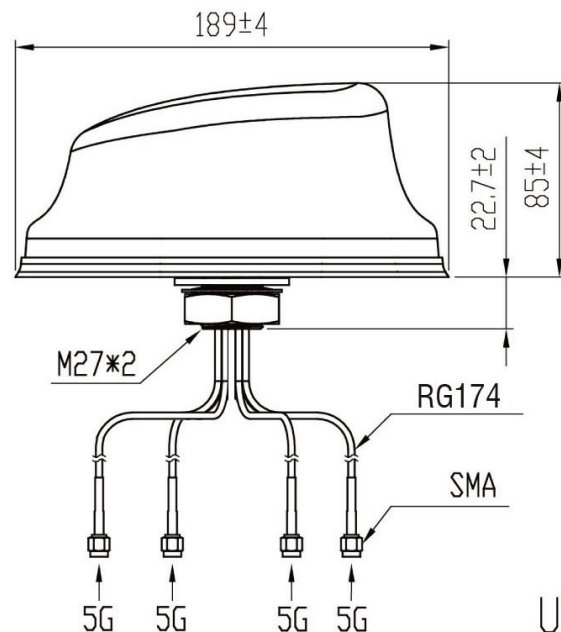
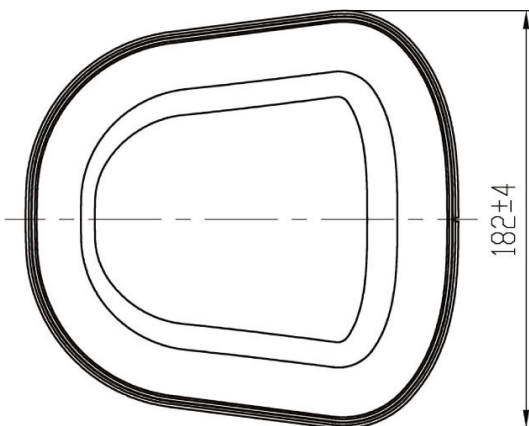

UNIT:mm

Antenna 193841



5G MIMO×4 Antenna

Radiation Pattern



NR Antenna

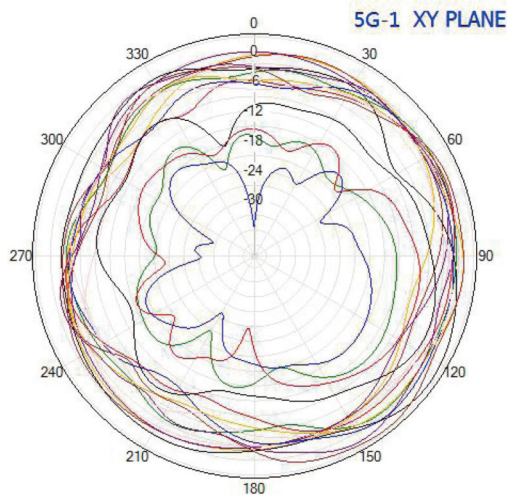

- 1710MHz
- 1850MHz
- 1990MHz
- 2170MHz
- 2300MHz
- 2500MHz
- 2690MHz
- 3300MHz
- 3800MHz
- 4400MHz
- 4800MHz
- 5000MHz
- 698MHz
- 824MHz
- 868MHz
- 960MHz

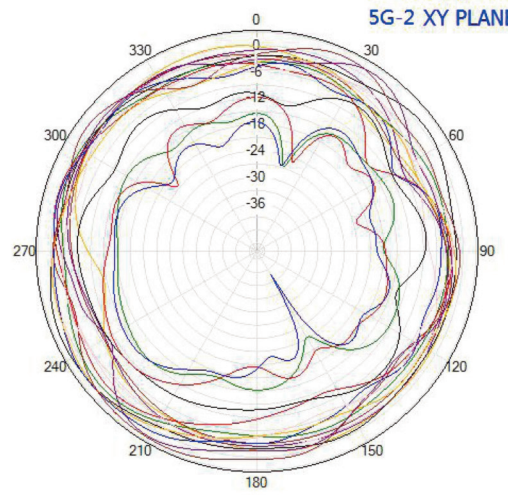

- 1710MHz
- 1850MHz
- 1990MHz
- 2170MHz
- 2300MHz
- 2500MHz
- 2690MHz
- 3300MHz
- 3800MHz
- 4400MHz
- 4800MHz
- 5000MHz
- 698MHz
- 824MHz
- 868MHz
- 960MHz

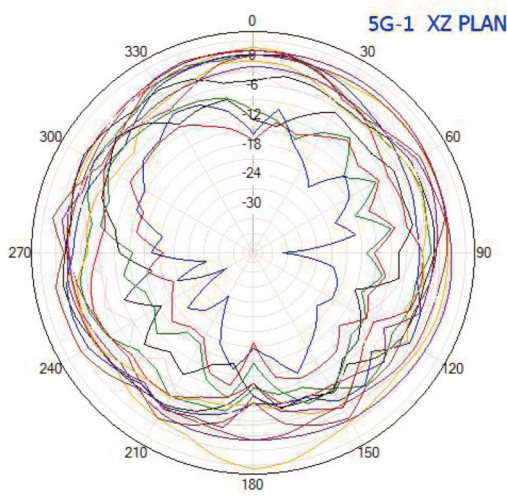

- 1710MHz
- 1850MHz
- 1990MHz
- 2170MHz
- 2300MHz
- 2500MHz
- 2690MHz
- 3300MHz
- 3800MHz
- 4400MHz
- 4800MHz
- 5000MHz
- 698MHz
- 824MHz
- 868MHz
- 960MHz

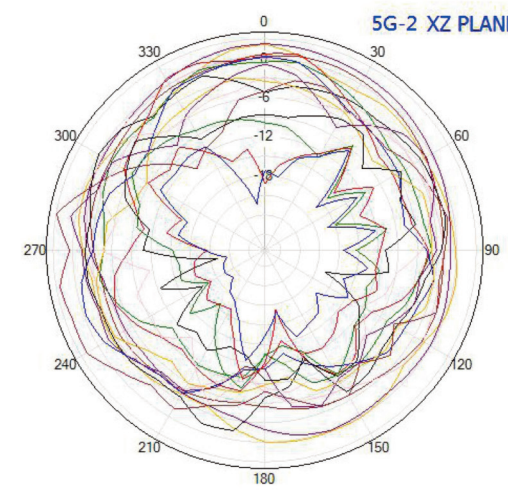

- 1710MHz
- 1850MHz
- 1990MHz
- 2170MHz
- 2300MHz
- 2500MHz
- 2690MHz
- 3300MHz
- 3800MHz
- 4400MHz
- 4800MHz
- 5000MHz
- 698MHz
- 824MHz
- 868MHz
- 960MHz

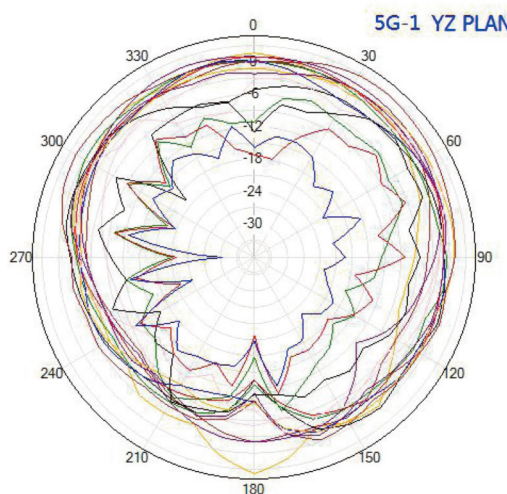

- 1710MHz
- 1850MHz
- 1990MHz
- 2170MHz
- 2300MHz
- 2500MHz
- 2690MHz
- 3300MHz
- 3800MHz
- 4400MHz
- 4800MHz
- 5000MHz
- 698MHz
- 824MHz
- 868MHz
- 960MHz

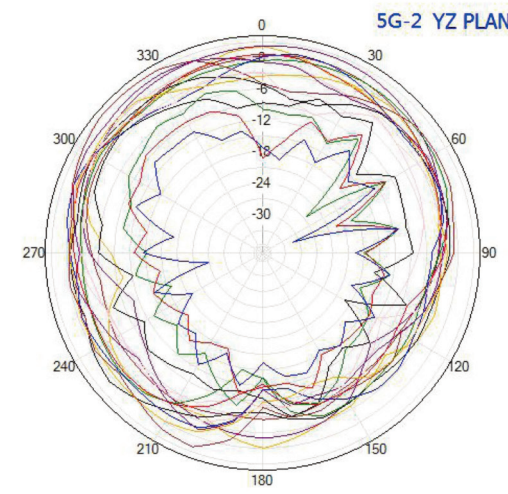

- 1710MHz
- 1850MHz
- 1990MHz
- 2170MHz
- 2300MHz
- 2500MHz
- 2690MHz
- 3300MHz
- 3800MHz
- 4400MHz
- 4800MHz
- 5000MHz
- 698MHz
- 824MHz
- 868MHz
- 960MHz

5G MIMO×4 Antenna

Radiation Pattern

