

Sensorsteckverbinder Serie 713 - 763

Sensor connectors series 713 - 763

Bezeichnung
Description

Flanschdose positionierbar, mit Litzen, 0,14mm²/0,25mm²
Female socket, positioning possible, with wires, 0,14mm²/0,25mm²

Flanschdose, von vorn verschraubbar, mit Litzen, 0,14mm²/0,5mm²
Female socket, front fastened, with wires, 0,14mm²/0,5mm²

Abbildung
Figure



Maßzeichnung
Drawing

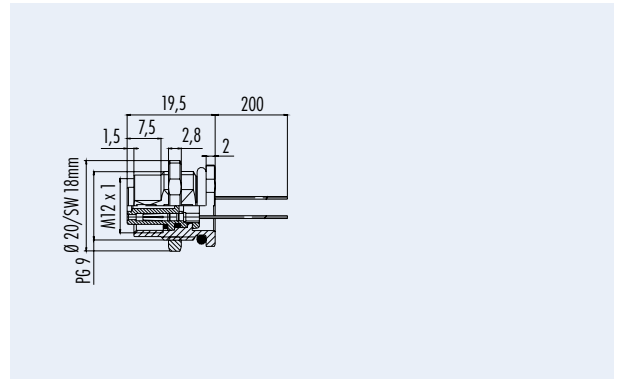
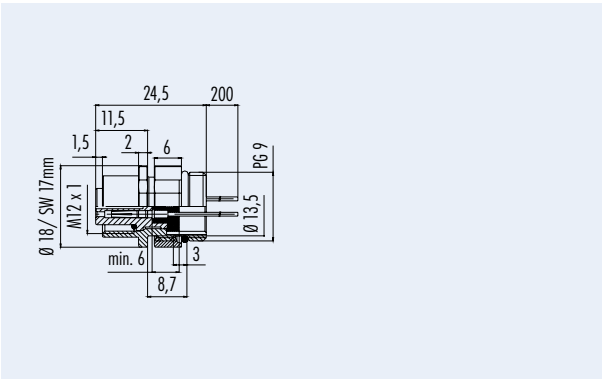

Bestell-Nr.
Ordering-No.

Polzahl Contacts	Befestigungsgewinde Fixing thread	Bestell-Nr. Ordering-Number	
4	PG 9	09-3432-22-04	RI
	M16 x 1,5	09-3432-722-04	RI
	PG 9 VA/stainless steel	09-3432-678-04	
5	PG 9	09-3442-22-05	RI
	M16 x 1,5	09-3442-722-05	RI
	PG 9 VA/stainless steel	09-3442-678-05	
8	PG 9	09-3482-22-08	
	M16 x 1,5	09-3482-722-08	
	PG 9 VA/stainless steel	09-3482-678-08	
12	PG 9	09-3492-22-12	
	M16 x 1,5	09-3492-722-12	

Polzahl Contacts	Befestigungsgewinde Fixing thread	Bestell-Nr. Ordering-Number
4	PG 9	09-3432-87-04
5	PG 9	09-3442-87-05
	PG 9 VA/stainless steel	09-3442-679-05
8	PG 9	09-3482-87-08
	PG 9 VA/stainless steel	09-3482-679-08
12	PG 9	09-3492-87-12

Technische Daten
Specifications

Polzahl	4	5	8	12	Number of contacts
Steckverbinder Verriegelung	schraub/screw				Connector locking system
Anschlussart	Litzen/wires				Termination
Anschlussquerschnitt	0,25 mm ² (AWG 24), 0,5 mm ² (AWG 20)		0,14 mm ² (AWG 26)		Wire gauge
Kabeldurchlass	-				Cable outlet
Schutzart	IP 68				Degree of protection
Mechanische Lebensdauer	> 100 Steckzyklen/> 100 mating cycles				Mechanical operation
Obere Grenztemperatur	+ 85 °C				Upper temperature
Untere Grenztemperatur	- 25 °C				Lower temperature
Bemessungsspannung	250 V	125 V	60 V	30 V	Rated voltage
Bemessungs-Stoßspannung	2500 V	1500 V	800 V	500 V	Rated impulse voltage
Verschmutzungsgrad	3				Pollution degree
Überspannungskategorie	II				Overvoltage categorie
Isolierstoffgruppe	II				Material group
Bemessungsstrom (40 °C)	4 A		2 A	1 A	Rated current (40 °C)
Durchgangswiderstand	≤ 3 mΩ				Contact resistance
Material Kontakt	CuSn (Bronze/bronze)				Material of contact
Kontaktoberfläche	Au (Gold/gold)				Contact plating
Material Kontaktkörper	PA				Material of contact body
Material Gehäuse	Messing/Zink Druckguss vernickelt/Edelstahl/brass/zinc diecasting nickel plated/stainless steel				Material of housing

Sensorsteckverbinder Serie 763 Sensor connectors series 763

Polbilder
Contact arrangements

Stifteinsatz (Steckseite)
Male insert (mating side)

Buchseinsatz (Steckseite)
Female insert (mating side)

3 pol
3 contacts

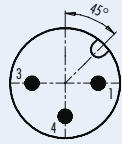

- 1 braun/brown
- 3 blau/blue
- 4 schwarz/black

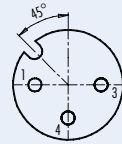

- 1 braun/brown
- 3 blau/blue
- 4 schwarz/black

4 pol
4 contacts

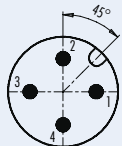

- 1 braun/brown
- 2 weiß/white
- 3 blau/blue
- 4 schwarz/black

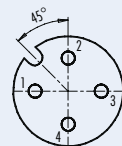

- 1 braun/brown
- 2 weiß/white
- 3 blau/blue
- 4 schwarz/black

5 pol
5 contacts

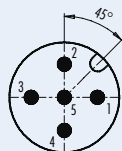

- 1 braun/brown
- 2 weiß/white
- 3 blau/blue
- 4 schwarz/black
- 5 grau/grey

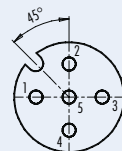

- 1 braun/brown
- 2 weiß/white
- 3 blau/blue
- 4 schwarz/black
- 5 grau/grey

8 pol
8 contacts

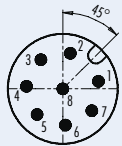

- | geschirmt/
shielded | nicht geschirmt/
not shielded |
|------------------------|----------------------------------|
| 1 weiß/white | 1 weiß/white |
| 2 braun/brown | 2 braun/brown |
| 3 grün/green | 3 grün/green |
| 4 gelb/yellow | 4 gelb/yellow |
| 5 grau/grey | 5 grau/grey |
| 6 rosa/pink | 6 rosa/pink |
| 7 blau/blue | 7 blau/blue |
| 8 rot/red | 8 Schirm/shield |
- Gehäuse-Schirm/
Housing-shield

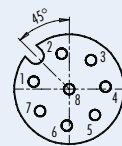

- | geschirmt/
shielded | nicht geschirmt/
not shielded |
|------------------------|----------------------------------|
| 1 weiß/white | 1 weiß/white |
| 2 braun/brown | 2 braun/brown |
| 3 grün/green | 3 grün/green |
| 4 gelb/yellow | 4 gelb/yellow |
| 5 grau/grey | 5 grau/grey |
| 6 rosa/pink | 6 rosa/pink |
| 7 blau/blue | 7 blau/blue |
| 8 rot/red | 8 Schirm/shield |
- Gehäuse-Schirm/
Housing-shield

12 pol
12 contacts

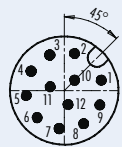

- 1 braun/brown
- 2 blau/blue
- 3 weiß/white
- 4 grün/green
- 5 rosa/pink
- 6 gelb/yellow
- 7 schwarz/black
- 8 grau/grey
- 9 rot/red
- 10 violett/purple
- 11 grau/rosa/grey/pink
- 12 rot/blau/red/blue

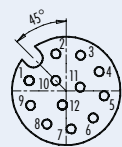

- 1 braun/brown
- 2 blau/blue
- 3 weiß/white
- 4 grün/green
- 5 rosa/pink
- 6 gelb/yellow
- 7 schwarz/black
- 8 grau/grey
- 9 rot/red
- 10 violett/purple
- 11 grau/rosa/grey/pink
- 12 rot/blau/red/blue

Sensorsteckverbinder Serie 713 · 763
Sensor connectors series 713 · 763

Montageausschnitt
Panel cut out

Mit Durchgangsbohrung/With bore hole

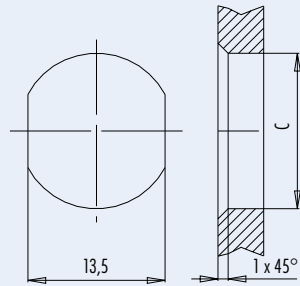

Mit Gewinde, einschraubbar/With thread to screw in

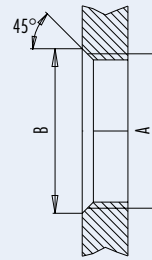

	A	B	C
PG9	PG9	16,2	15,3
M16	M16	17,0	16,1

Anzugsdrehmoment nach DIN VDE 0619
 Tightening moment acc. to DIN VDE 0619

Metallgehäuse/Metal housing 6,25 Nm
 Kunststoffgehäuse/Plastic housing 3,75 Nm

alternativ/alternativ

Kennlinie
Rating

Schirmdämpfungskurve nach DIN 47250-6
 für Kabelsteckverbinder, gerade Ausführung
 (Kabeltyp IEEE 802.3)

Attenuation curve according to DIN 47250-6
 for straight cable connectors
 (cable version IEEE 802.3)

