

External Mount 4G/5G

MiMo Antenna

WMMG-7-38

PANORAMA ANTENNAS



- Provides 2x2 MiMo antenna system for 4G/5G
- Two wideband elements with medium gain
- Durable housing for external or internal use
- Suitable for mast, wall and desk mounting

The WMMG antenna provides an innovative and future proof solution for 3G/4G and 3.4-3.8GHz 5G networks. Incorporating two separately fed, ultra wideband elements in a single housing, it provides a client side 2x2 MiMo antenna system for the networks of today and tomorrow. With between 2-5dBi gain in the range 698-3800MHz, the WMMG gives great performance, whilst maintaining a wide beam pattern which is ideal for metro and urban areas.

The rugged, weatherproof housing is designed for wall or mast mounting and hardware is provided. A desk stand is also included to enable the antenna to be positioned on a window sill if preferred.

The antenna is supplied with integral "twinned" CS29 coaxial cable. WMMG-7-38-5SP version has 5m length, fitted with sma plug connectors for a simple 'plug & play' installation. WMMG-7-38-03NJ version has 30cm length, fitted with N socket connectors, which enables use of lower loss cable types for longer runs.

The WMMG is a cost effective value added product for network operators and service providers ensuring a stable network connection with improved data rates for subscribers, improving satisfaction and retention.

Technical Drawing

WMMG-7-38-5SP Shown

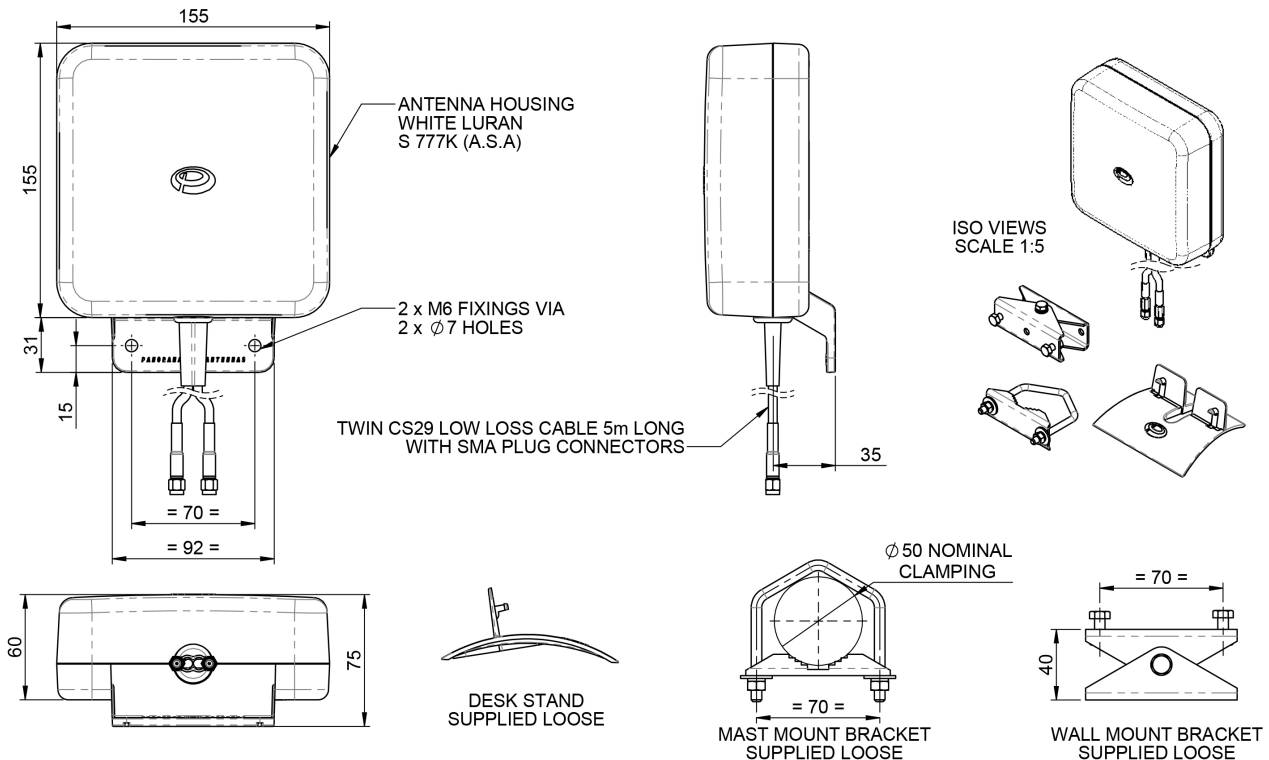

External Mount 4G/5G

MiMo Antenna

WMMG-7-38

Product Data

Part No.	WMMG-7-38-5SP	WMMG-7-38-03NJ
Frequency Range	Element 1	698-960 / 1710-2700 / 3400-3800 MHz
	Element 2	698-960 / 1710-2700 / 3400-3800 MHz
Operational bands	3G/4G/5G	
VSWR (excluding cable)	< 2:1	
Peak Gain (excluding cable loss)	698-960 MHz	2dBi
	1710-2700 MHz	5dBi
	3400-3800MHz	4dBi
Correlation Co-efficient (all bands)	< 0.2	
Typical Element Isolation	> 20dB	
Max Input Power	20 W	
Impedance	50Ω	
Mechanical Data		
Dimensions	Height	155mm (6.1")
	Width	155mm (6.1")
Operating Temp.	-30° / +80°C (-22° / 176°F)	
Material	ASA	
Colour	White	
Weight (including cable)	950g	430g
Ingress Protection	IP65	
Mounting Data		
Fixing	Wall mount / Mast mount / Desk mount	
Mounting Bracket Material	Stainless steel / Aluminium	
Pole Diameter	20-50mm / (0.78 - 1.96")	
Cable Data		
Type	2 x CS29 (4G/5G)	
Diameter	5mm (0.2")	
Length	5m (16')	0.3m (1')
Termination	2x SMA (M)	2x N JACK (F)

External Mount 4G/5G

MiMo Antenna

WMMG-7-38

Electrical Data - Cell

Typical VSWR Elements 1 & 2 *

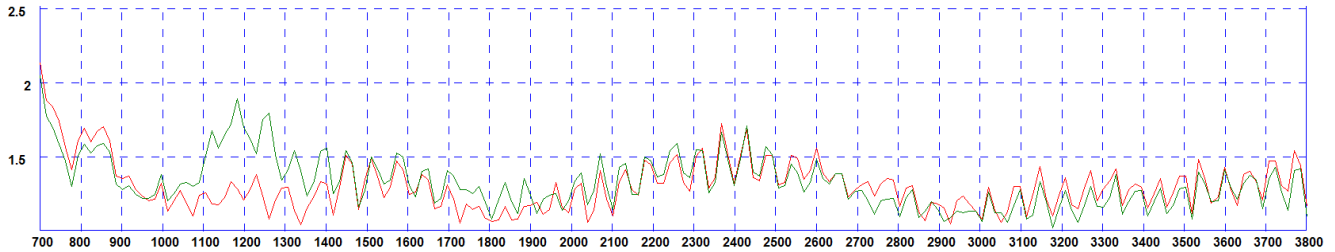

*VSWR Measured with 5m (16') of CS29 cable

Typical VSWR Elements 1 & 2 *

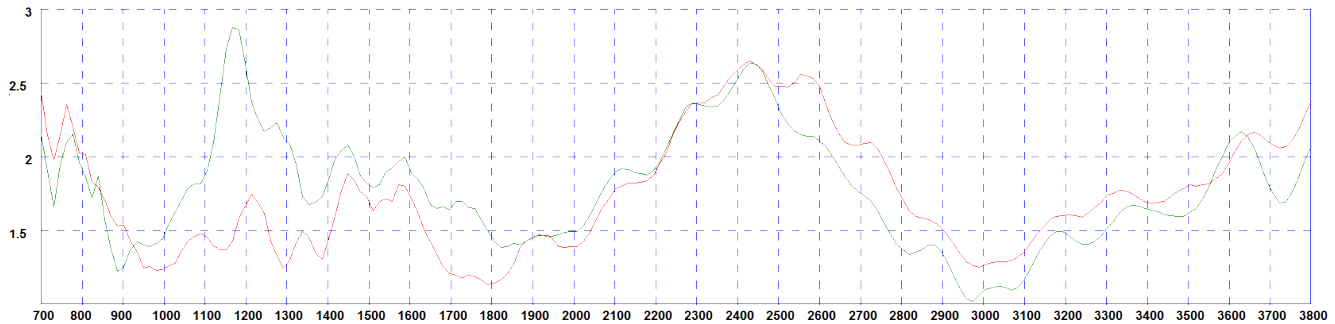

*VSWR measured without cable

Typical Isolation Elements 1 & 2 *

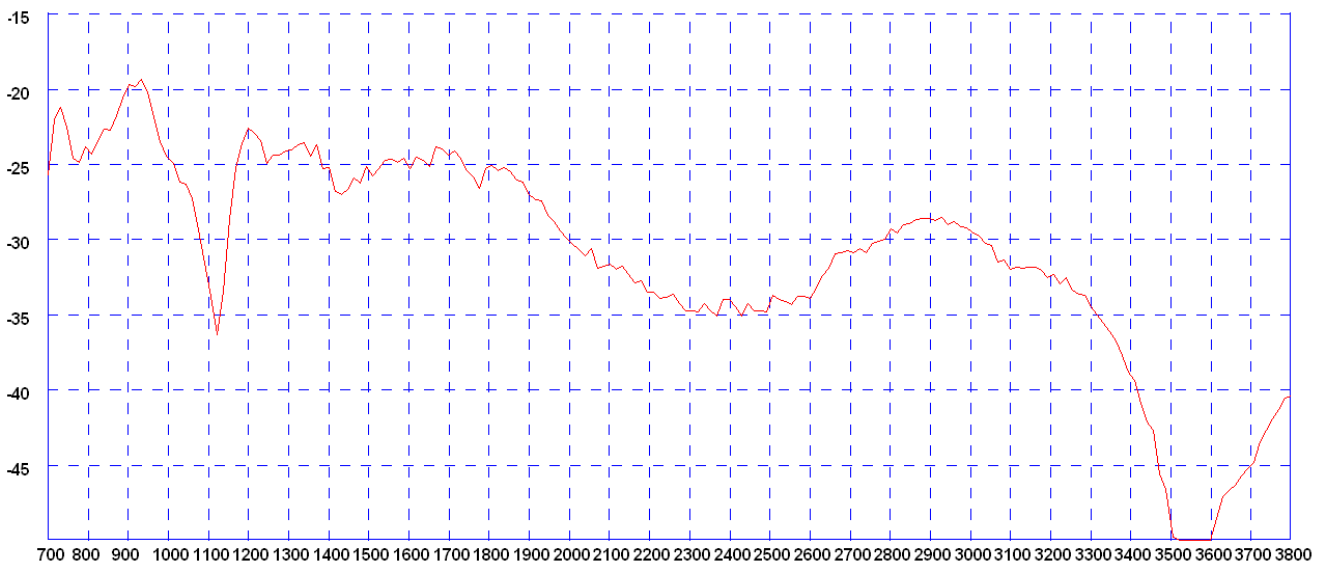

* Isolation measured with 5m (16') of CS29 cable

3D Gain Plot (750MHz)

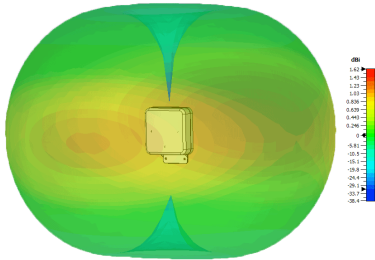

3D Gain Plot (850MHz)

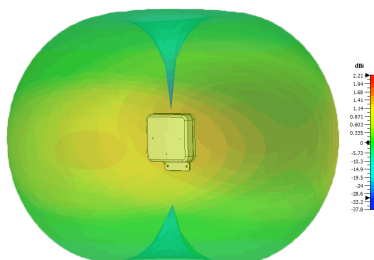

3D Gain Plot (950MHz)

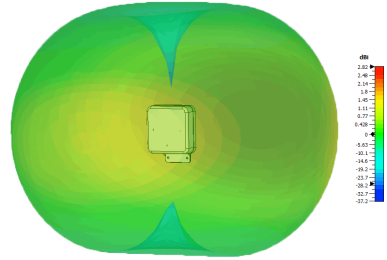

3D Gain Plot (1800MHz)

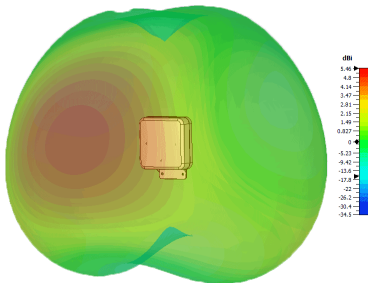

3D Gain Plot (1900MHz)

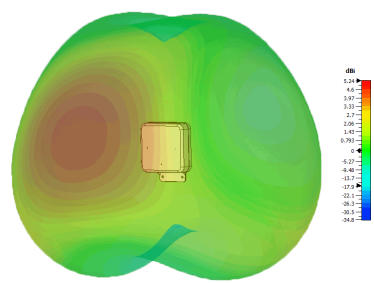

3D Gain Plot (2100MHz)

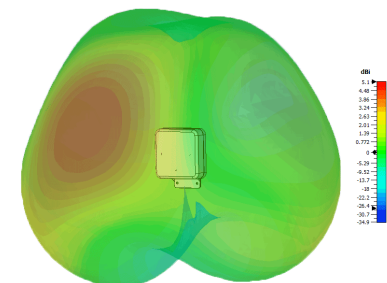

3D Gain Plot (2600MHz)

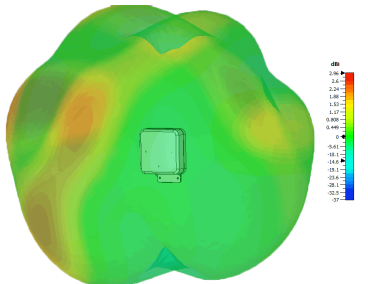

3D Gain Plot (3600MHz)

