

Antenna 194679

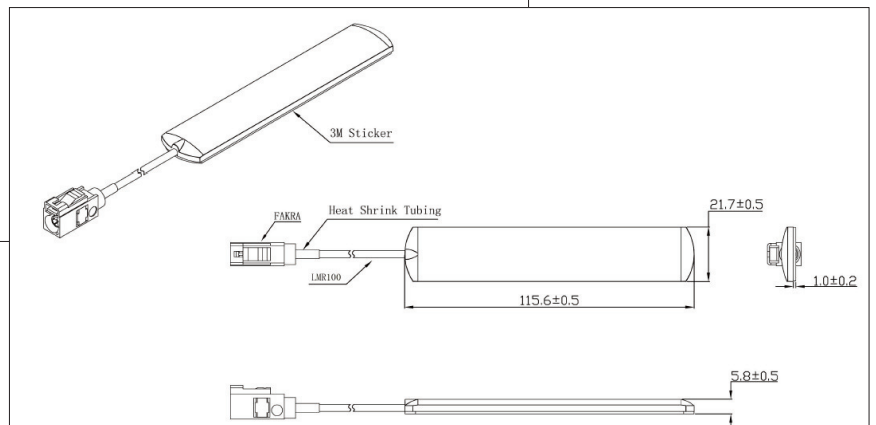

LTE + 450 MHz combi antenna

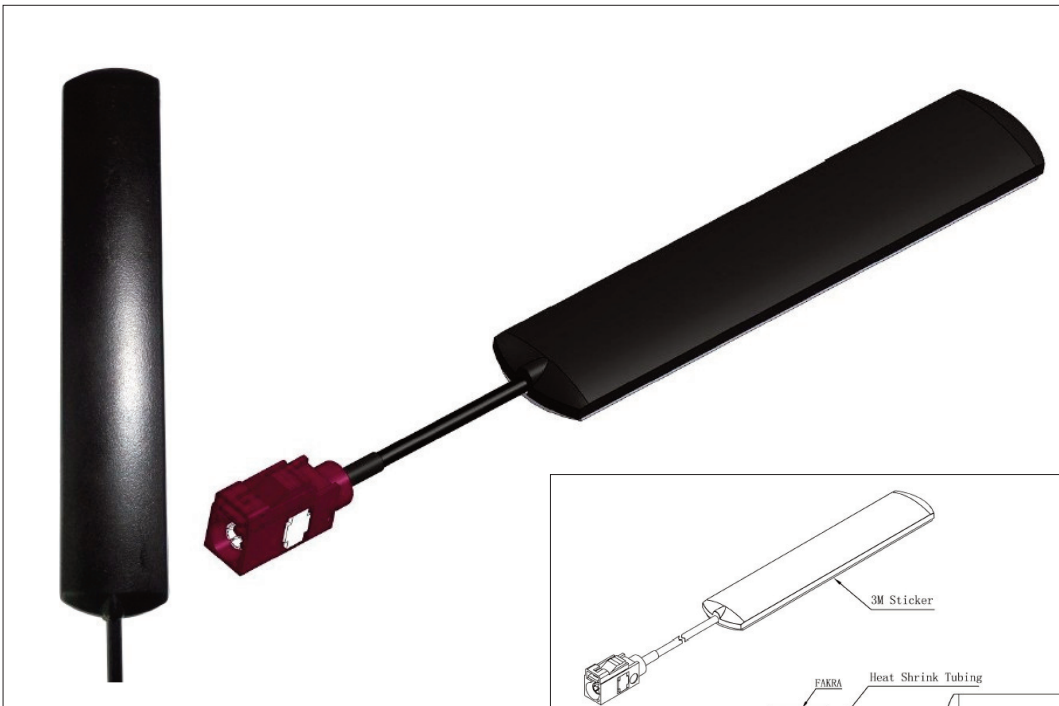

Technical Data:

Frequency Range	451-468/617-960/1427-1518/1710-2690/3300-3800/4400-4900 MHz
Polarization	Linear
Gain	max. 2.0 dBi
V.S.W.R	< 3.0
Impedance	50Ω
PCB Dimension	104.6 x 18 x 1 mm
Cable	3 m RG174
Connector	Fakra-D R/A
Radome Material	ABS
Mounting Method	Adhesive
Operating Temperature	-40°C to +85°C
Relative Humidity	Up to 95%
Vibration	10 to 55Hz with 1.5mm amplitude 2hours
Environmentally Friendly	ROHS Compliant