

Antenna 194830



LTE Magnetic Mount Antenna



Technical Data:

Standards	4G, 3G and 2G
Frequency	698-960, 1710-2170, 2500-2700 MHz
Return Loss (dB)	~-13.7, ~-16.0, ~-10.3
VSWR	~1.6:1, ~1.4:1, ~2.0:1
Efficiency (%)	~69.6, ~61.4, ~37.0
Peak Gain (dBi)	~1.6, ~2.6, ~1.1
Impedance (Ohm)	50
Polarisation	Linear
Radiation Pattern	Omni-Directional
Max. Input Power (W)	35
Cable	3 m RG174
Connector	SMA (male)

Mechanical Data:

Mounting Type	Magnetic Mount
Dimensions (mm)	Ø 54 × 219
Operating Temperature	-40 °C to +85 °C
Substance Compliance	RoHS

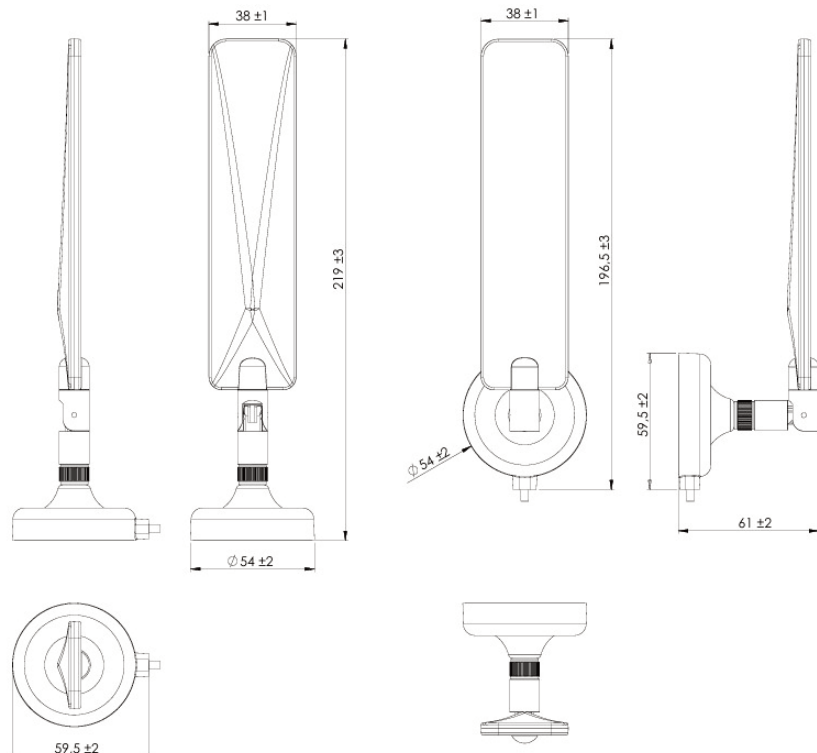

Antenna 194830



LTE Magnetic Mount Antenna

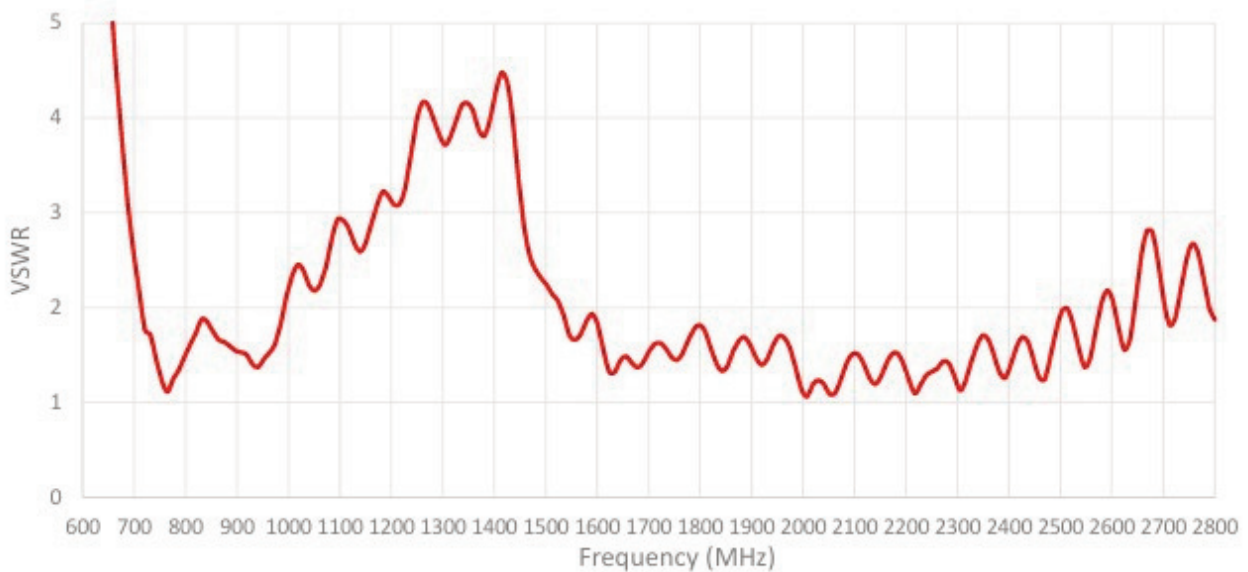
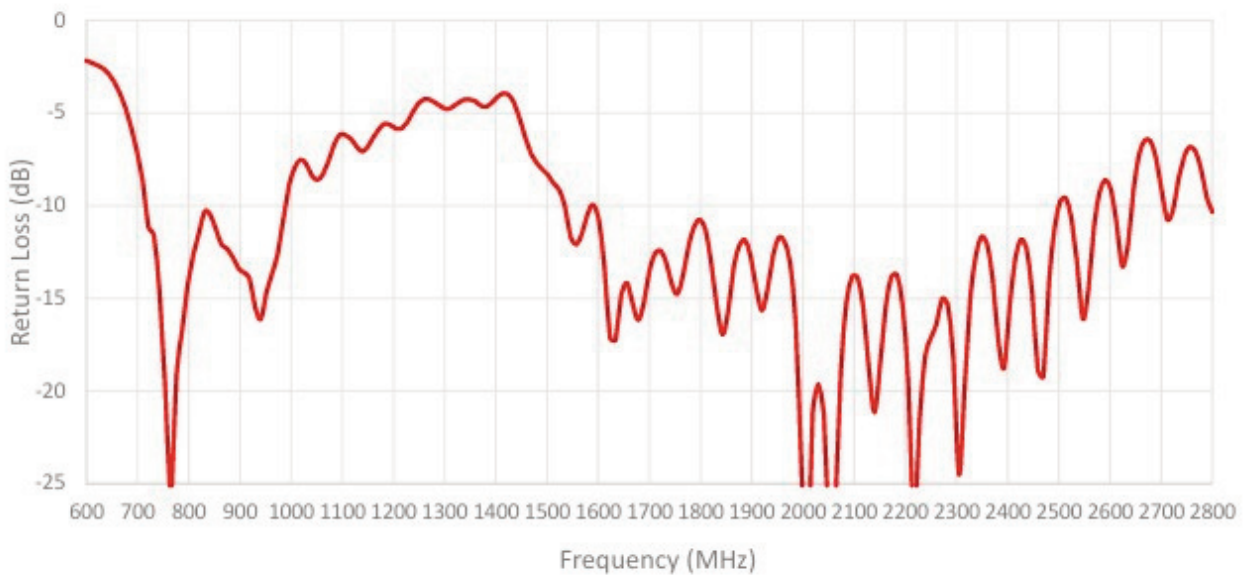

Antenna 194830



LTE Magnetic Mount Antenna

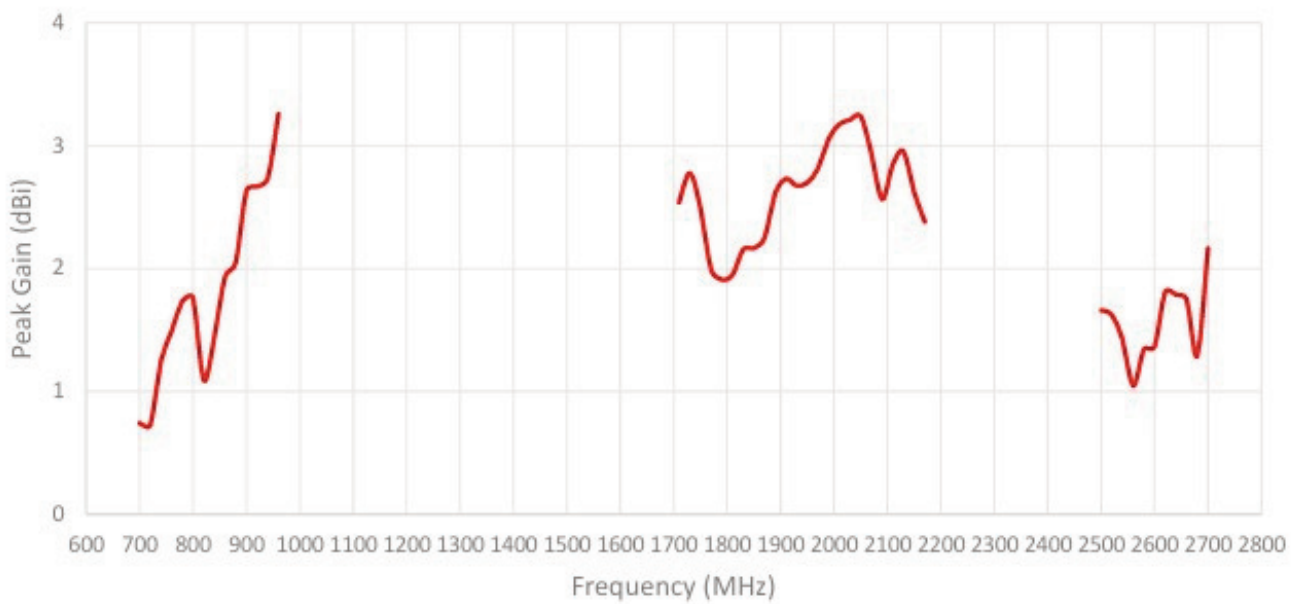
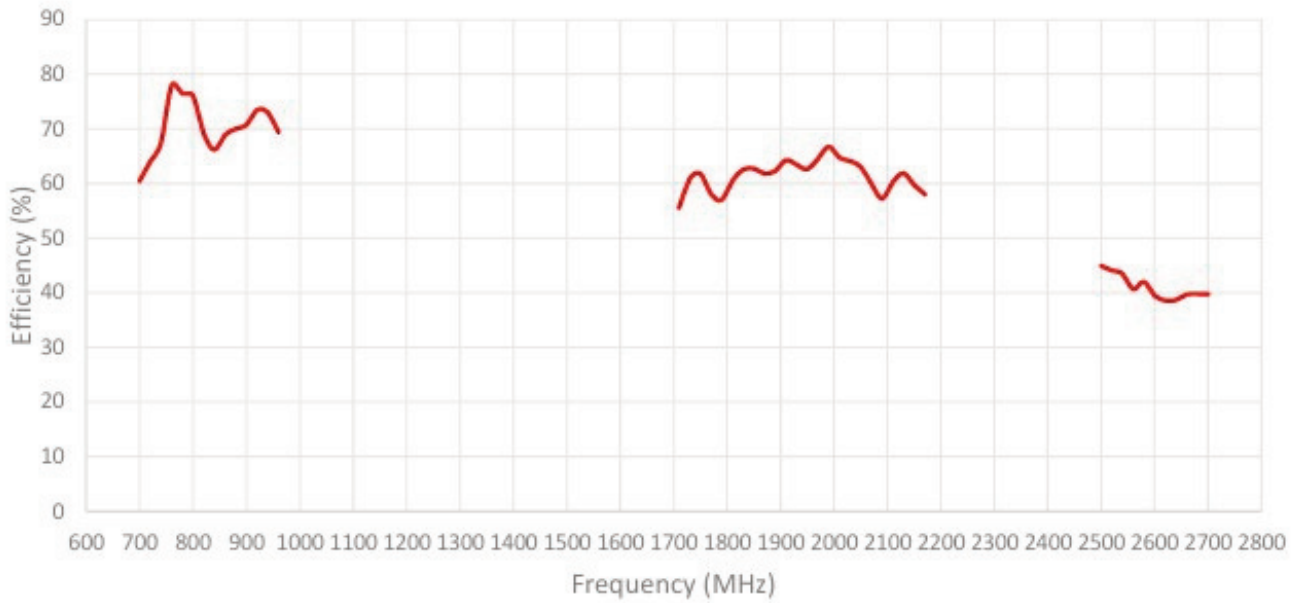

LTE Magnetic Mount Antenna

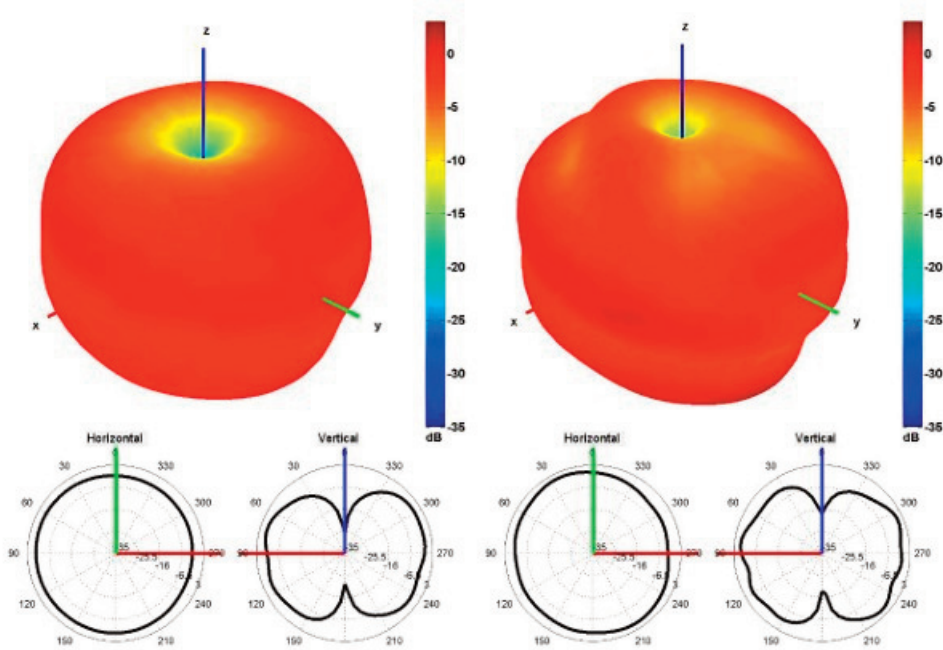

750 and 850 MHz Radiation pattern

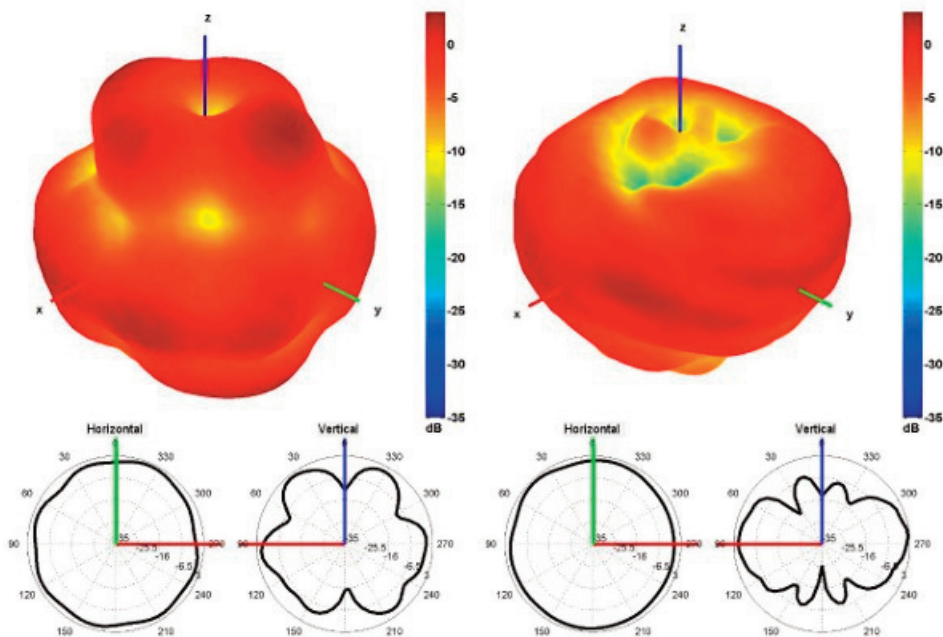

940 and 1750 MHz Radiation pattern

Antenna
194830



LTE Magnetic Mount Antenna

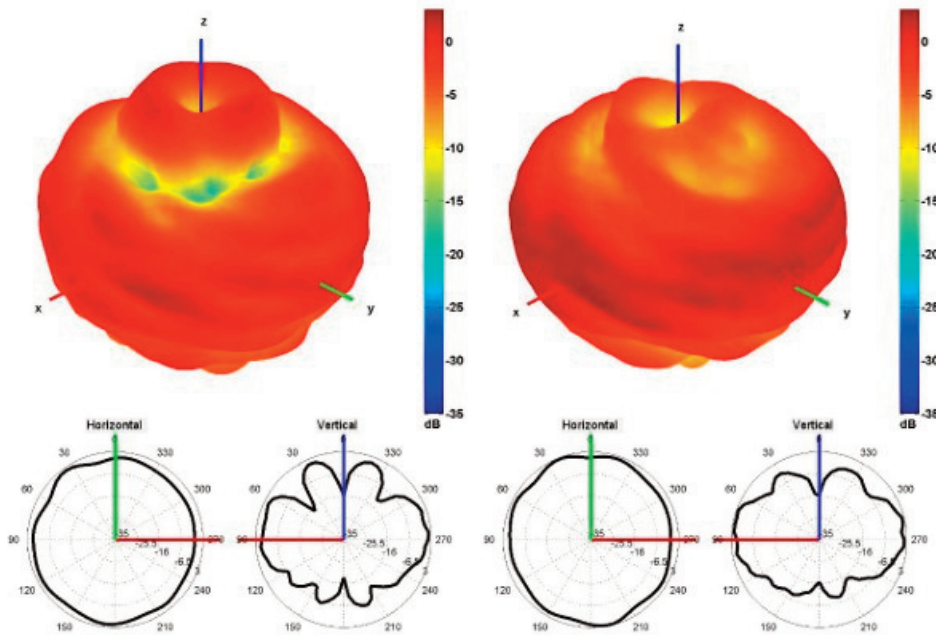

1850 and 1950 MHz Radiation pattern

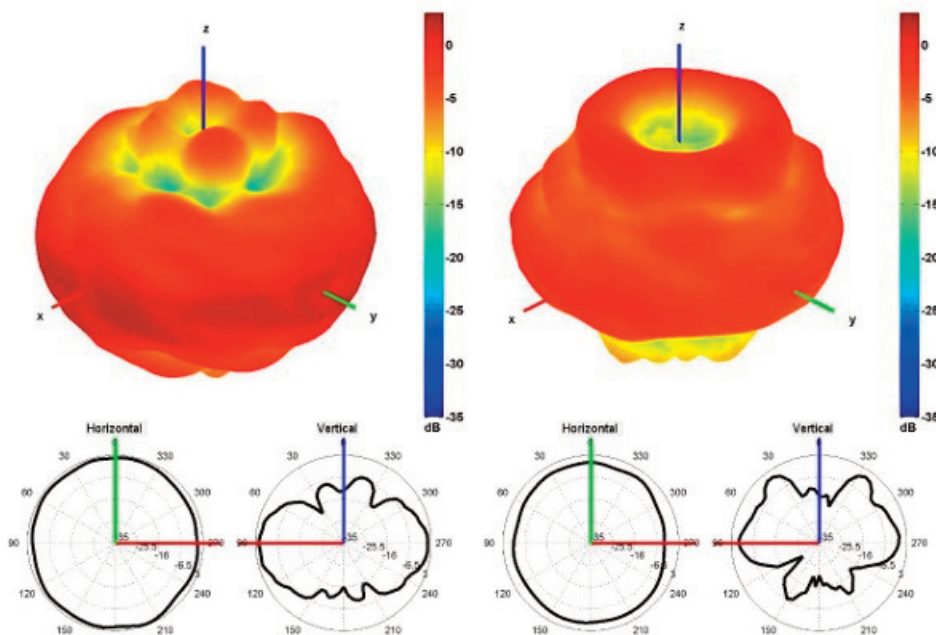

2100 and 2600 MHz Radiation pattern