

Antenna 194842



5G NR/4G/3G/2G Connector Mount



Technical Data:

Standards	5G, 4G, 3G and 2G
Frequency	617-960, 1427-2690, 3300-5000, 5150-5925 MHz
Return Loss (dB)	~-9.3, ~-9.8, ~-6.9, ~-13.7
VSWR	~2.4:1, ~2.2:1, ~3.1:1, ~1.6:1
Efficiency (%)	~45.8, ~58.6, ~41.8, ~46.9
Peak Gain (dBi)	~2.2, ~2.6, ~2.0, ~4.2
Impedance (Ohm)	50
Polarisation	Linear
Radiation Pattern	Omni-Directional
Max. Input Power (W)	25
Cable	without
Connector	SMA (male)

Mechanical Data:

Mounting Type	Connector Mount
Dimensions (mm)	170 × 18 × 10
Operating Temperature	-40 °C to +85 °C
Substance Compliance	RoHS

Right Angle position



Straight position



45° Angle position

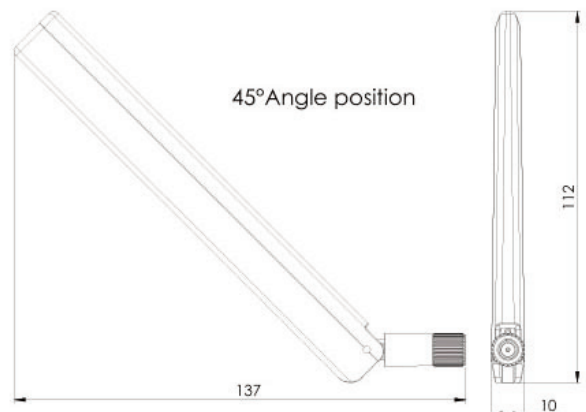

Antenna 194842



5G NR/4G/3G/2G Connector Mount

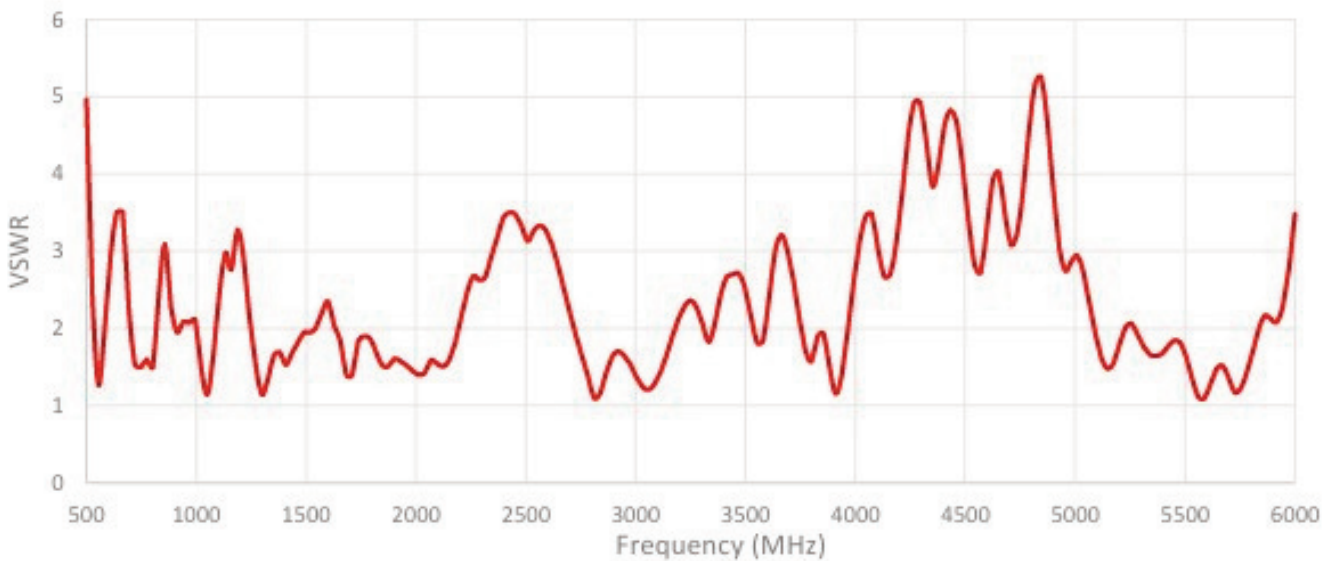
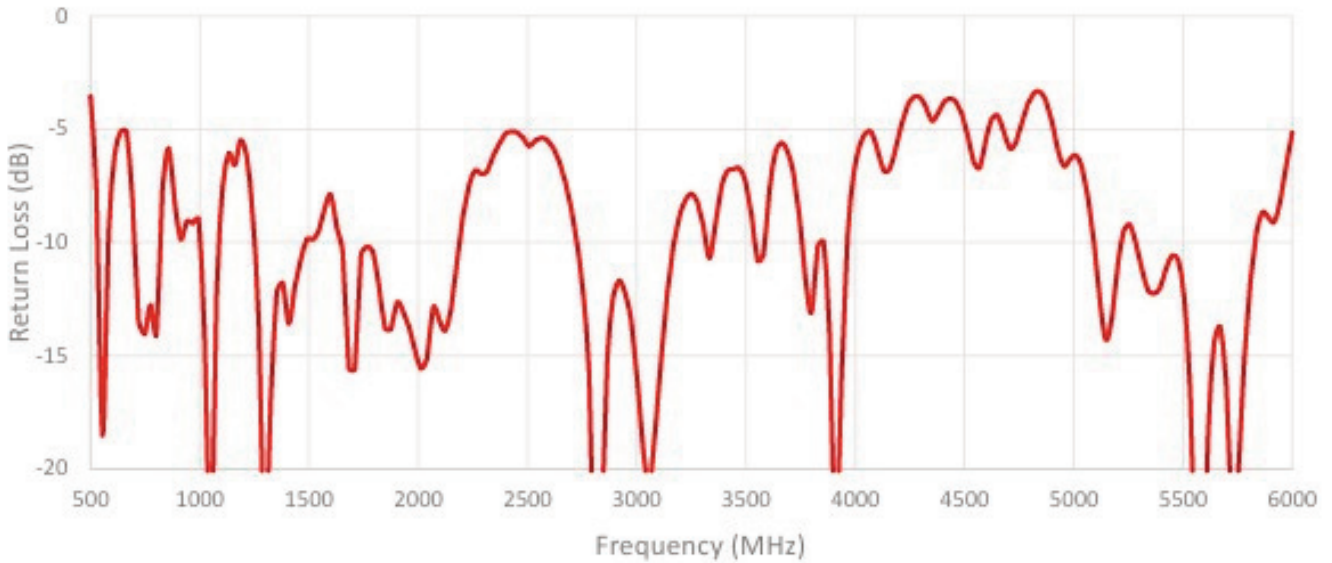

Antenna 194842



5G NR/4G/3G/2G Connector Mount

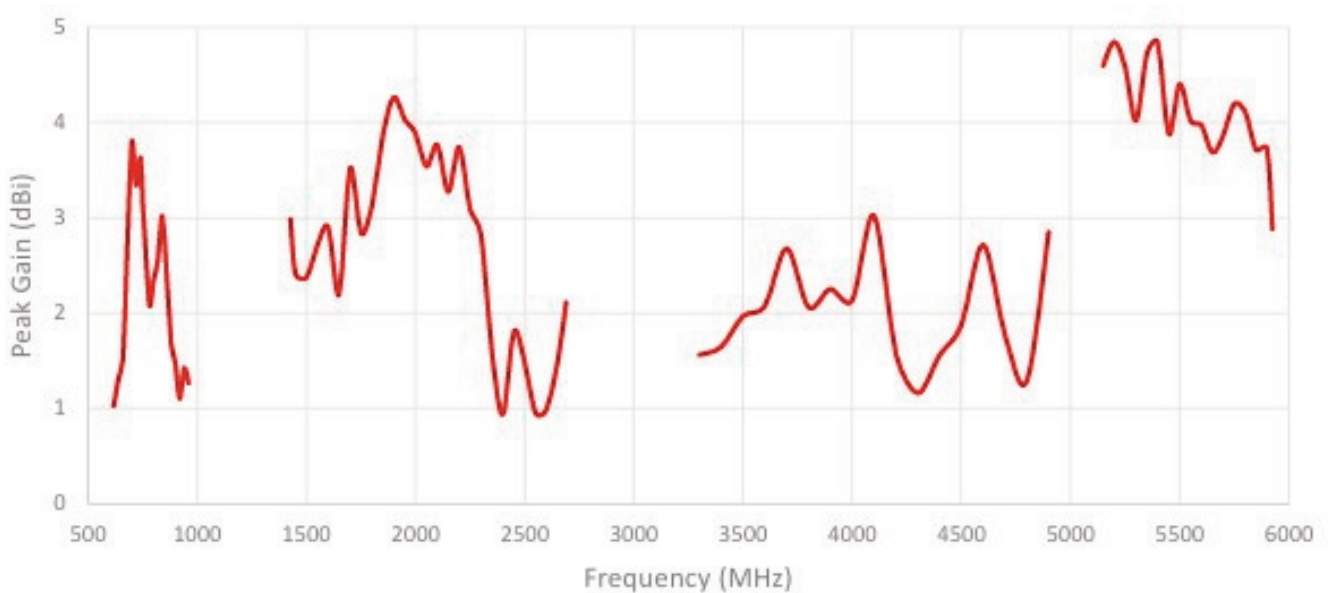
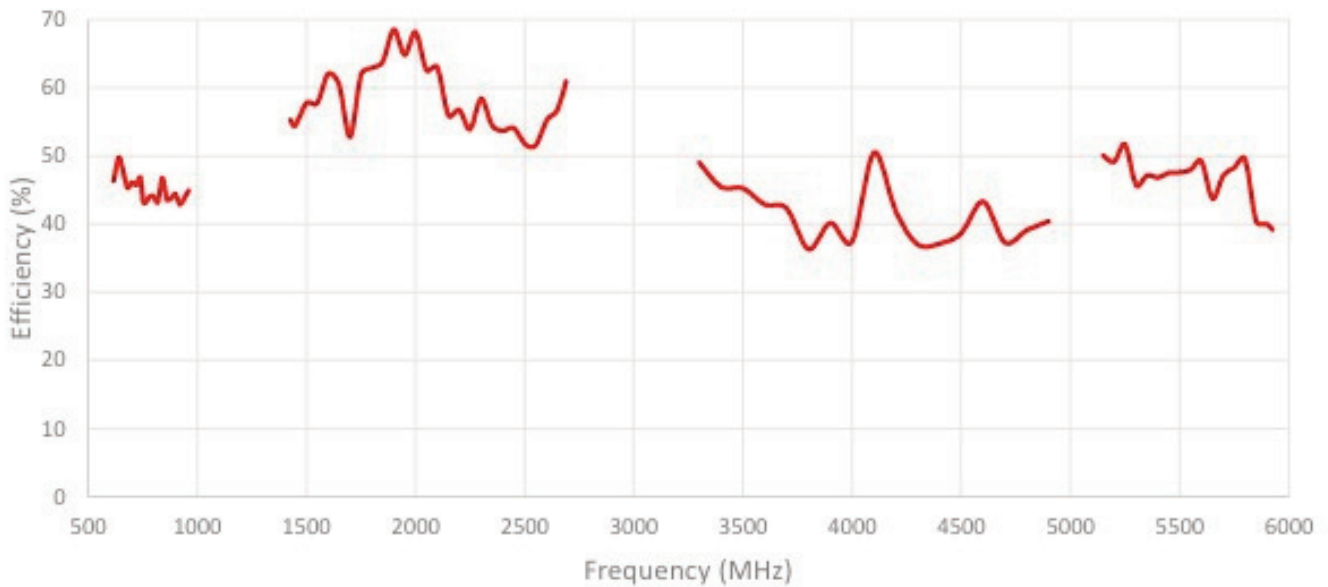

5GNR/4G/3G/2G Connector Mount

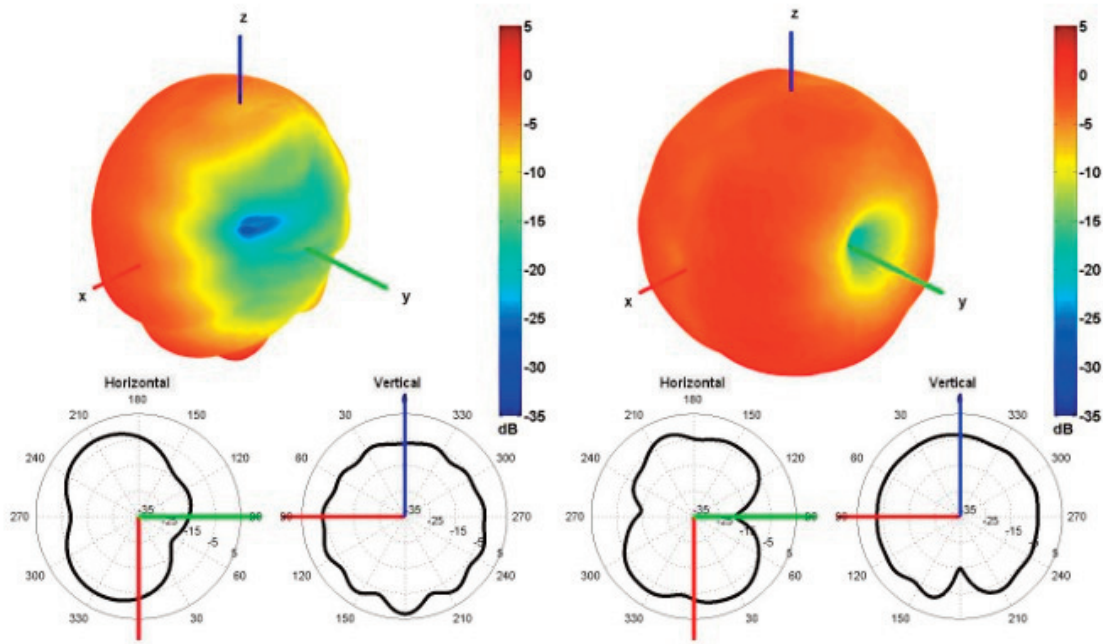

750 and 2500 MHz Radiation pattern

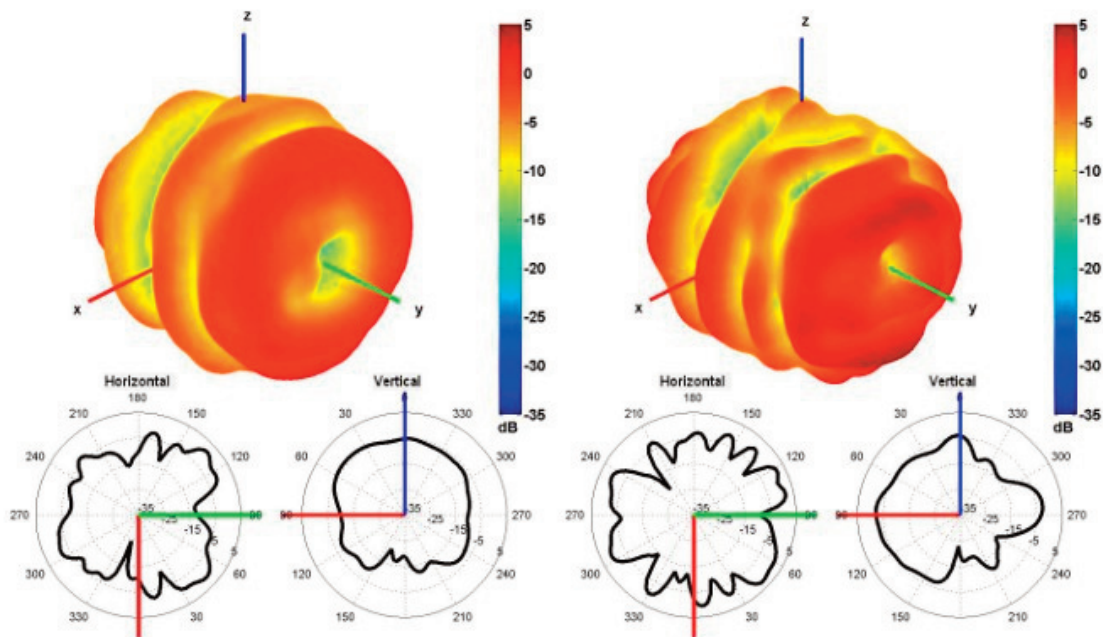

4500 and 5500 MHz Radiation pattern